

Hopper Guns (Gravity-Fed & Pressurized) 3A5724A

EN

For spray application of water-based architectural and texture coatings.

Air compressor for supplying air to hopper guns only.

Not approved for use in explosive atmospheres or hazardous (classified) locations.

For professional use only.

5 psi (0.03 MPa, 0.3 bar) Hopper Maximum Working Air Pressure

100 psi (0.69 MPa, 6.9 bar) Gun Maximum Working Air Pressure



Important Safety Instructions

Read all warnings and instructions in this manual before using the equipment.

Be familiar with the controls and the proper usage of the equipment.

Save these instructions.

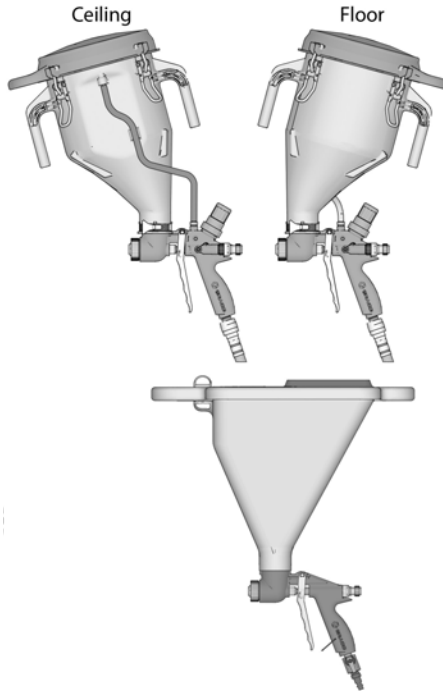

831471a



Component Identification

Component Identification

25D496 - Pressurized Hopper Gun

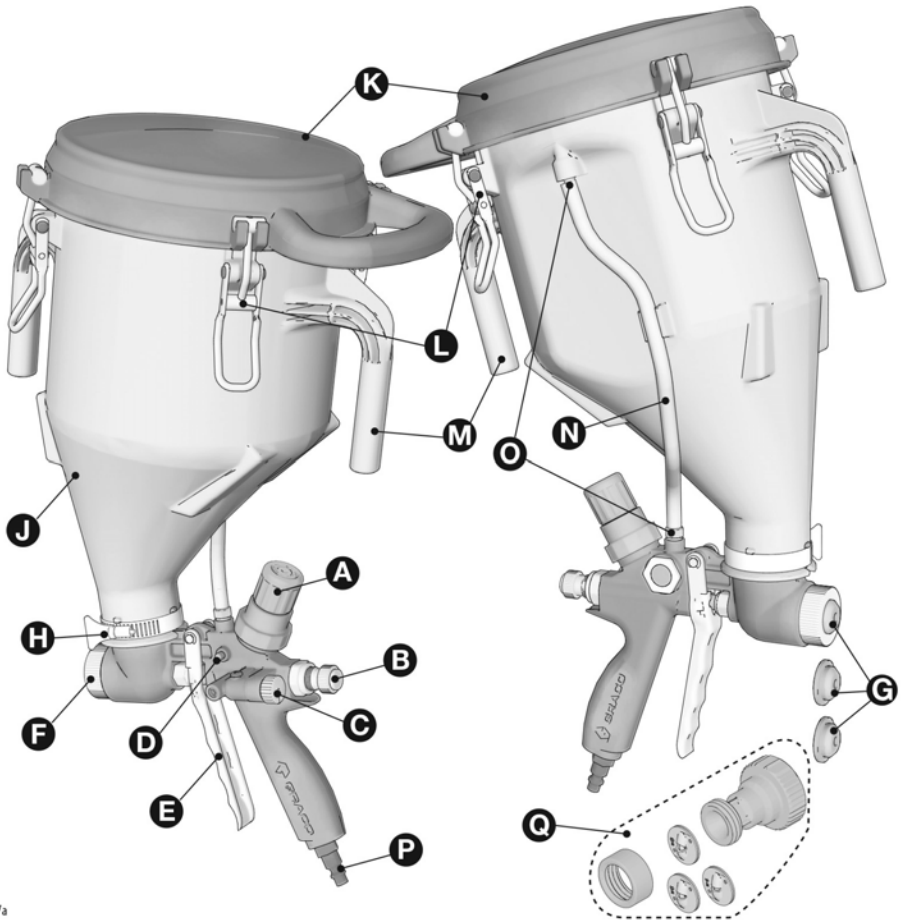

1133417a

A	Material Flow Regulator (Push down to lock. Pull up to unlock)
B	Needle Travel Adjustment Knob
C	Air Flow Valve
D	Pressure Relief Valve
E	Trigger
F	Nozzle Retainer
G	Material Nozzles (4mm, 6mm & 8mm)
H	Hopper Clamp

J	Hopper
K	Hopper Lid
L	Lid Clamps
M	Hopper Handle
N	Hopper Air Supply Tube
O	Hopper Tube Barbs
P	Air Hose Fitting
Q	WideTex Kit

Component Identification

25D497 - Gravity-Fed Hopper Gun

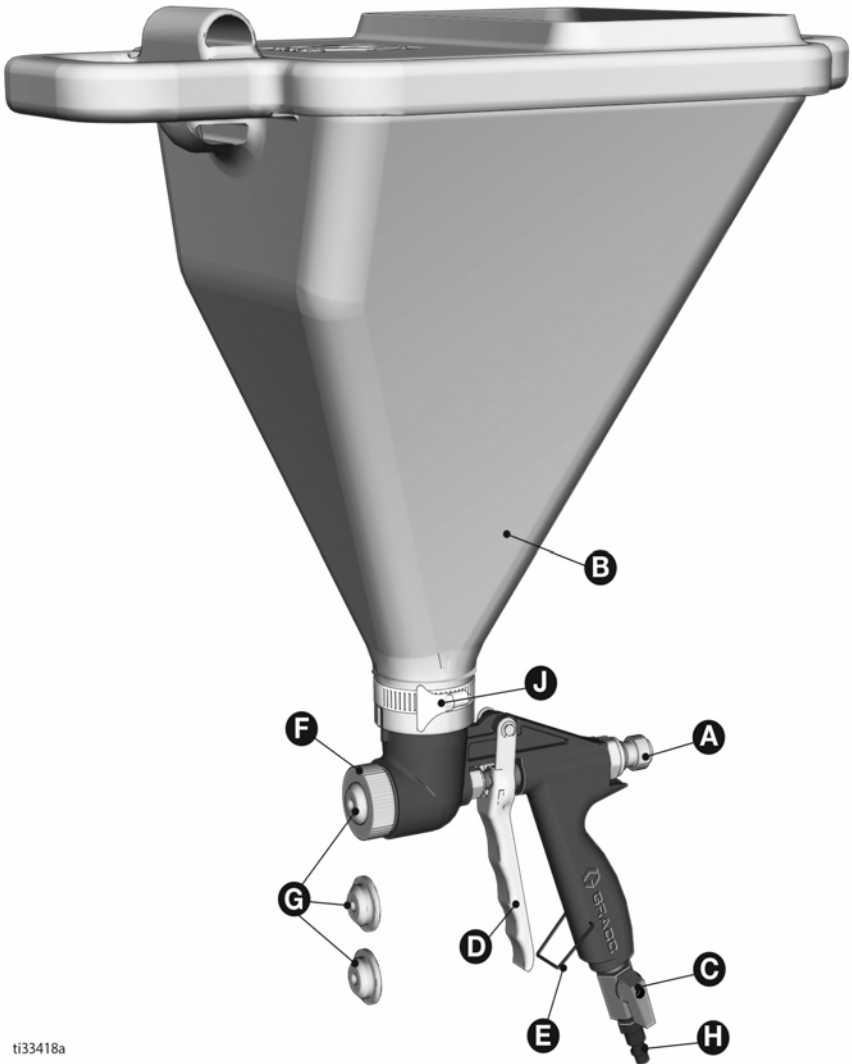

ti33418a

A	Needle Travel Adjustment Knob
B	Hopper
C	Air Valve
D	Trigger
E	Trigger Lock

F	Nozzle Retainer
G	Material Nozzles (4mm, 6mm & 8mm)
H	Air Hose Fitting
J	Hopper Clamp

Pressure Relief Procedure

Pressure Relief Procedure



Follow the Pressure Relief Procedure whenever you see this symbol.



The hopper is pressurized. To reduce the risk of splashing from pressurized fluid, always follow the **Pressure Relief Procedure** before removing the hopper from the gun.

1. Turn air compressor ON/OFF switch to the **OFF** position.

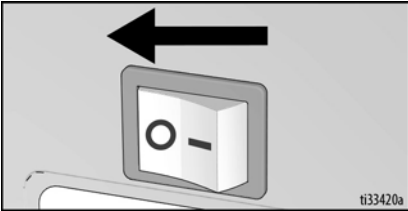

2. Unplug power cord.

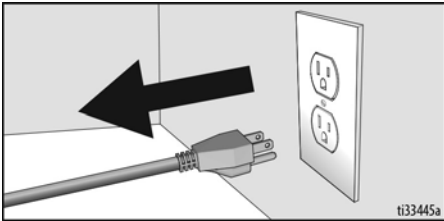

3. Disconnect spray gun from air hose.

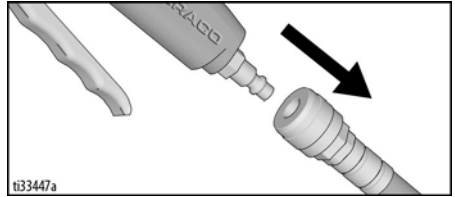

4. Open pressure relief valve on gun by pressing button (pressurized gun only). Aim gun into waste bucket and trigger the gun until all air and material pressure is relieved.

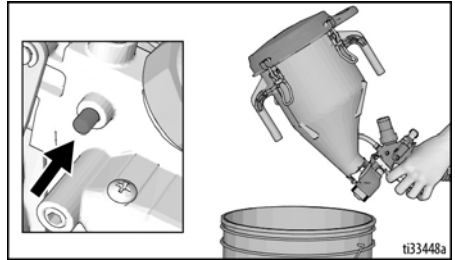

NOTICE

Do not relieve pressure by lifting the hopper clamps. Lifting the clamps while the hopper is pressurized may damage the hopper and/or hopper lid.

Repair

1. Test gun trigger. Lubricate needle seals if necessary.

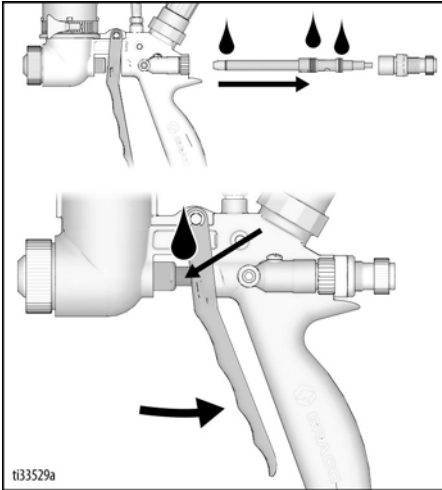

2. **Pressurized hopper gun only:** If lid is too loose and leaks air when pressurized, adjust the four lid clamps to tighten lid.

NOTE: Each clamp should be adjusted equally so the lid sits even on the hopper.

NOTICE

Over-tightening the lid may damage the hopper and/or hopper lid.

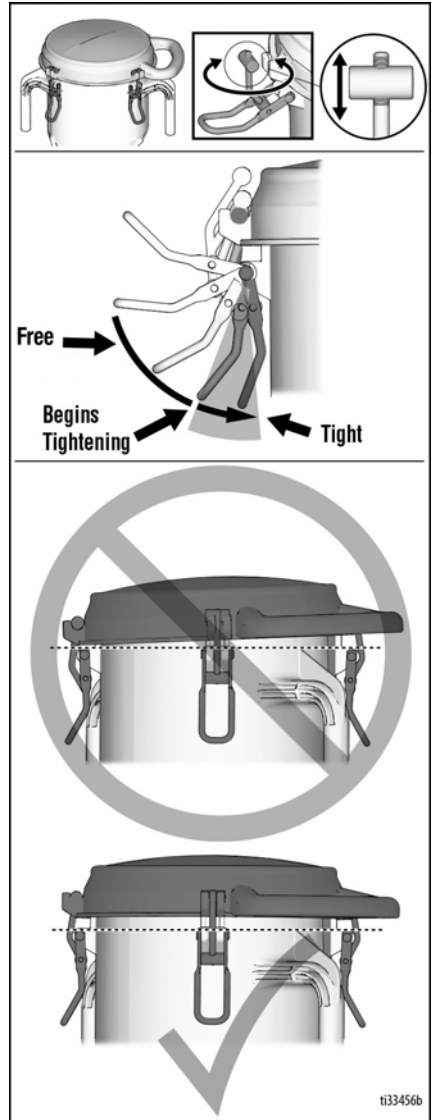

Parts - Pressurized Hopper 25D496

Parts - Pressurized Hopper 25D496

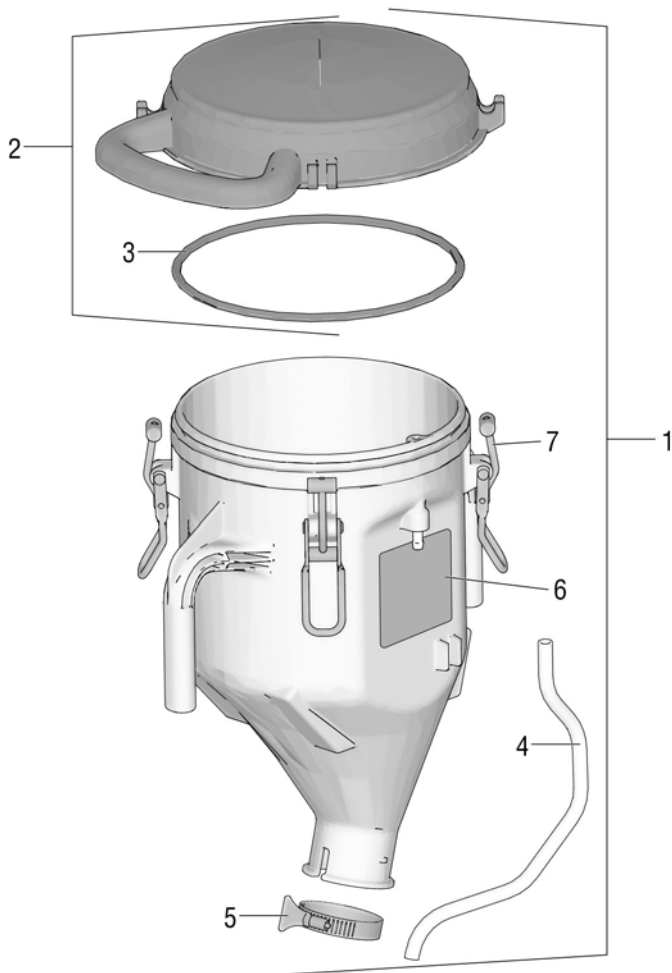

ti33414a

Ref. Part	Description	Qty	Ref. Part	Description	Qty
1	17V946 HOPPER, assembly	1	5	17V223 CLAMP, hopper	1
2	17V947 LID, hopper, pressurized	1	6▲	17W855 LABEL, safety, warning, rupture	1
3	17V246 O-RING	1	7	17V709 PIN	4
4	17V945 TUBE	1			

▲ Replacement Danger and Warning labels, tags, and cards are available at no cost.

Parts - Pressurized Gun 25D496

Parts - Pressurized Gun 25D496

Ref.	Notes
①	Torque to 45 in-lbs (5.1 N•m)
②	Torque to 5-7 in-lbs (0.6 - 0.8 N•m)
③	Torque to 25 in-lb (2.8 N•m)
④	Apply pipe thread sealant
⑤	Apply blue Loctite sealant
⑥	Lubricate all o-rings with grease

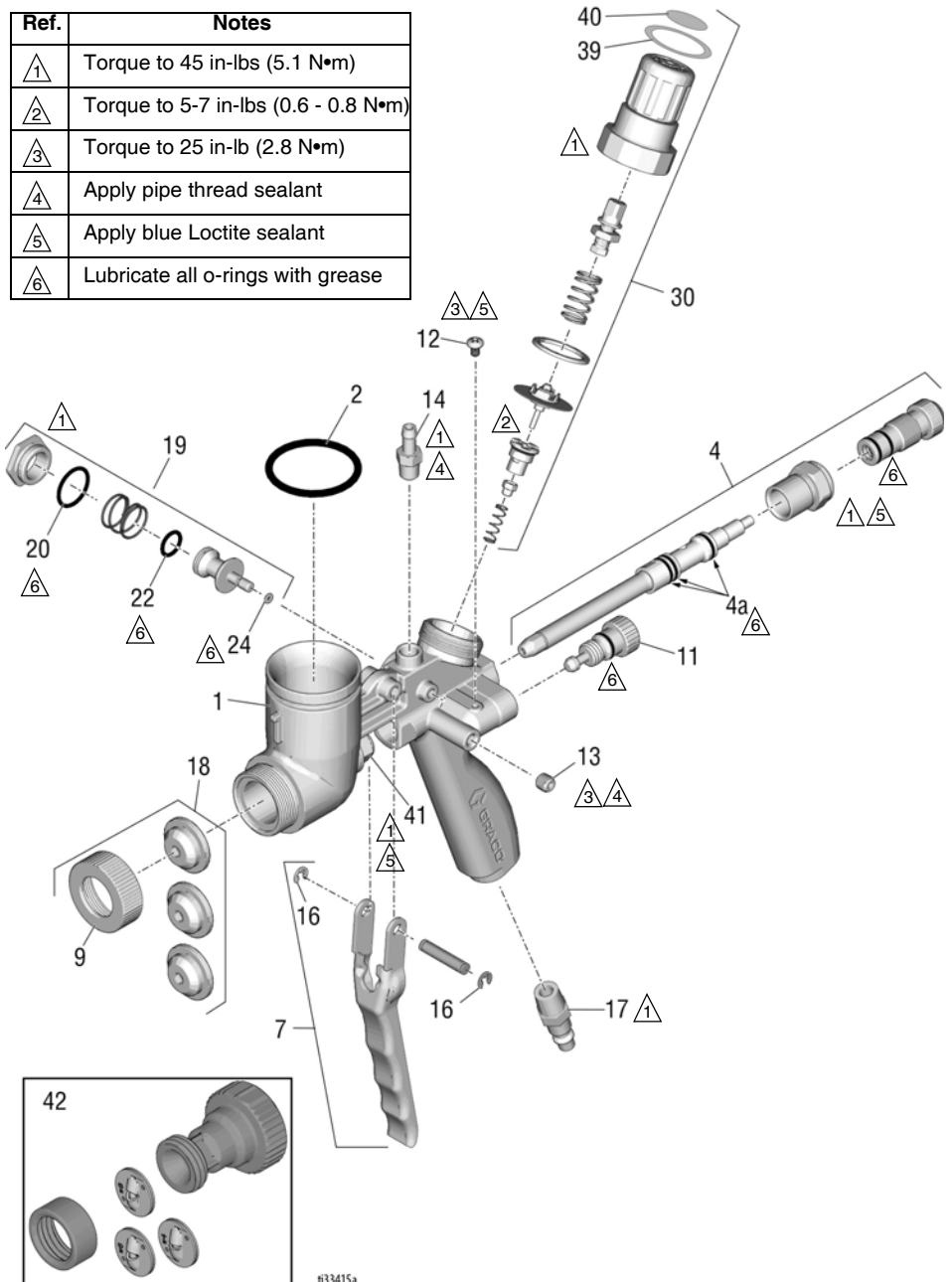

ti33415a

Parts List - Pressurized Gun 25D496

Parts List - Pressurized Gun 25D496

Ref.Part	Description	Qty	Ref.Part	Description	Qty
1	GUN, body, pressurized	1	24†	O-RING	1
2†	17V705 O-RING	1	30 17V953	HOUSING, regulator <i>includes 31-40</i>	1
4	17V948 NEEDLE, assembly <i>includes 5, 6, 41</i>	1	31	ADJUSTER, regulator	1
4a	197650 O-RING	3	32	SPRING, adjusting, regulator	1
5	BUSHING	1	33	RING, retainer, regulator	1
6	KNOB, adjusting, assy	1	34	SPRING, seat, regulator	1
7	17V944 KIT, repair, trigger	1	35	SEAT, thread, regulator	1
9	17U921 CAP, retaining	1	36	HOLDER, diaphragm, assy.	1
11	17V980 KIT, repair, valve	1	37†	PACKING, o-ring	1
12	17V711 SCREW, 8-32 UNC	1	38	PLUG, sealing, regulator	1
13	17V710 PLUG, 1/16-27 NPT	1	39 17V664	LABEL, bonnet, regulator	1
14	17V192 FITTING, 1/8-27 NPT	1	40 17V665	LABEL, knob, regulator	1
16	131180 RETAINING, ring, 4mm	1	41 17V948	BOLT, needle, assy	1
17	119394 FITTING, line, air	1	42 17V692	KIT, widetex	1
18	17V694 KIT, nozzles (4mm, 6mm, 8mm)	1	17V691	ADAPTER, housing	1
19	17V952 KIT, repair, air relief valve <i>includes 20-24</i>	1	17H637	NUT, retaining	1
20†	O-RING	1	24S099	TIP, disk, spray, W4	1
21	SPRING, valve, relief	1	24S100	TIP, disk, spray, W6	1
22†	O-RING	1	24S101	TIP, disk, spray, W8	1
23	PISTON, valve, relief	1			

† Included in Repair Kit 17V951

Parts - Gravity-Fed Hopper Gun 25D497

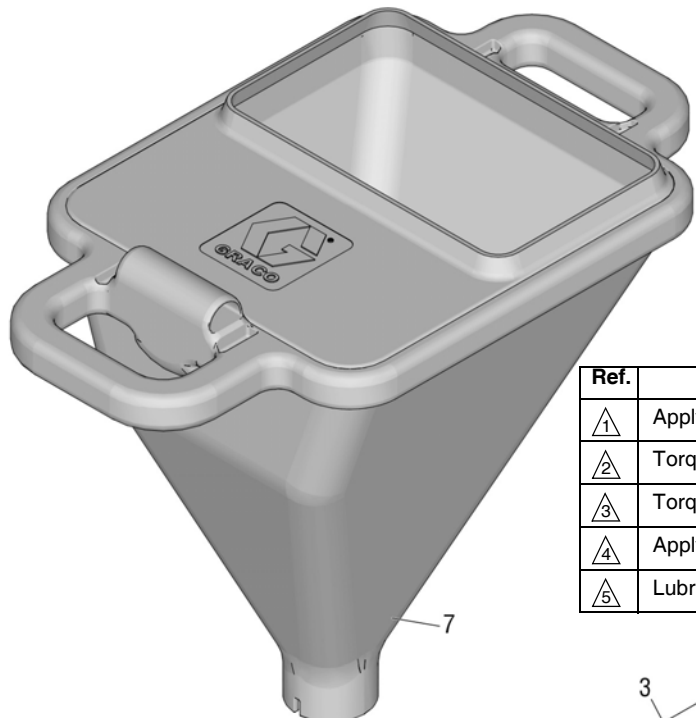

Ref.	Notes
①	Apply pipe thread sealant
②	Torque to 115 in-lbs (13.0 N•m)
③	Torque to 45 in-lbs (5.1 N•m)
④	Apply blue Loctite sealant
⑤	Lubricate all o-rings with grease

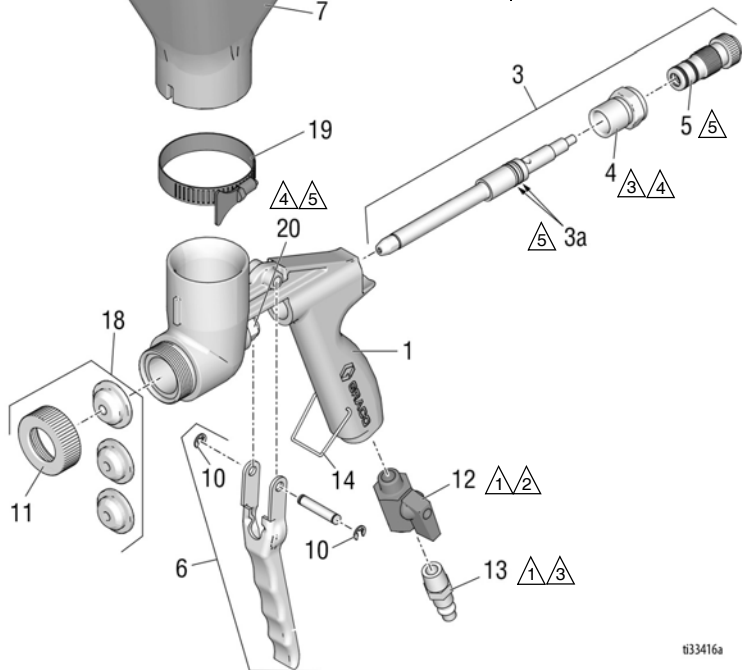

033416a

Parts List - Gravity-Fed Hopper Gun 25D497

Parts List - Gravity-Fed Hopper Gun 25D497

Ref.Part	Description	Qty	Ref.Part	Description	Qty
1	GUN, body, gravity-fed	1	10 131180	RING, retainer	1
3	17V949 KIT, repair, needle <i>includes 4, 5, 20</i>	1	11 17U921	CAP, retaining	1
3a	197650 O-RING	2	12 15B565	VALVE, ball	1
4	BUSHING	1	13 119394	FITTING, line, air	1
5	KNOB, adjusting, assy	1	14 17V042	LOCK, trigger	1
6	17V944 KIT, trigger, gun	1	18 17V694	KIT, nozzles (4mm, 6mm, 8mm)	1
7	276873 HOPPER, 1.5 gallon	1	19 17V223	CLAMP, hopper	1
9	PIN, dowel, trigger	2	17V954	KIT, o-ring	1
			20 17V949	KIT, repair, needle	1

Graco Standard Warranty

Graco warrants all equipment referenced in this document which is manufactured by Graco and bearing its name to be free from defects in material and workmanship on the date of sale to the original purchaser for use. With the exception of any special, extended, or limited warranty published by Graco, Graco will, for a period of twelve months from the date of sale, repair or replace any part of the equipment determined by Graco to be defective. This warranty applies only when the equipment is installed, operated and maintained in accordance with Graco's written recommendations.

This warranty does not cover, and Graco shall not be liable for general wear and tear, or any malfunction, damage or wear caused by faulty installation, misapplication, abrasion, corrosion, inadequate or improper maintenance, negligence, accident, tampering, or substitution of non-Graco component parts. Nor shall Graco be liable for malfunction, damage or wear caused by the incompatibility of Graco equipment with structures, accessories, equipment or materials not supplied by Graco, or the improper design, manufacture, installation, operation or maintenance of structures, accessories, equipment or materials not supplied by Graco.

This warranty is conditioned upon the prepaid return of the equipment claimed to be defective to an authorized Graco distributor for verification of the claimed defect. If the claimed defect is verified, Graco will repair or replace free of charge any defective parts. The equipment will be returned to the original purchaser transportation prepaid. If inspection of the equipment does not disclose any defect in material or workmanship, repairs will be made at a reasonable charge, which charges may include the costs of parts, labor, and transportation.

THIS WARRANTY IS EXCLUSIVE, AND IS IN LIEU OF ANY OTHER WARRANTIES, EXPRESS OR IMPLIED, INCLUDING BUT NOT LIMITED TO WARRANTY OF MERCHANTABILITY OR WARRANTY OF FITNESS FOR A PARTICULAR PURPOSE.

Graco's sole obligation and buyer's sole remedy for any breach of warranty shall be as set forth above. The buyer agrees that no other remedy (including, but not limited to, incidental or consequential damages for lost profits, lost sales, injury to person or property, or any other incidental or consequential loss) shall be available. Any action for breach of warranty must be brought within two (2) years of the date of sale.

GRACO MAKES NO WARRANTY, AND DISCLAIMS ALL IMPLIED WARRANTIES OF MERCHANTABILITY AND FITNESS FOR A PARTICULAR PURPOSE, IN CONNECTION WITH ACCESSORIES, EQUIPMENT, MATERIALS OR COMPONENTS SOLD BUT NOT MANUFACTURED BY GRACO. These items sold, but not manufactured by Graco (such as electric motors, switches, hose, etc.), are subject to the warranty, if any, of their manufacturer. Graco will provide purchaser with reasonable assistance in making any claim for breach of these warranties.

In no event will Graco be liable for indirect, incidental, special or consequential damages resulting from Graco supplying equipment hereunder, or the furnishing, performance, or use of any products or other goods sold hereto, whether due to a breach of contract, breach of warranty, the negligence of Graco, or otherwise.

FOR GRACO CANADA CUSTOMERS

The Parties acknowledge that they have required that the present document, as well as all documents, notices and legal proceedings entered into, given or instituted pursuant hereto or relating directly or indirectly hereto, be drawn up in English. Les parties reconnaissent avoir convenu que la rédaction du présente document sera en Anglais, ainsi que tous documents, avis et procédures judiciaires exécutés, donnés ou intentés, à la suite de ou en rapport, directement ou indirectement, avec les procédures concernées.

Graco Information

For the latest information about Graco products, visit www.graco.com.

For patent information, see www.graco.com/patents.

TO PLACE AN ORDER, contact your Graco distributor or call 1-800-690-2894 to identify the nearest distributor.

All written and visual data contained in this document reflects the latest product information available at the time of publication.

Graco reserves the right to make changes at any time without notice.

Original instructions. This manual contains English. MM 3A5724

Graco Headquarters: Minneapolis
International Offices: Belgium, China, Japan, Korea

GRACO INC. AND SUBSIDIARIES • P.O. BOX 1441 • MINNEAPOLIS MN 55440-1441 • USA

Copyright 2018, Graco Inc. All Graco manufacturing locations are registered to ISO 9001.

www.graco.com
Revision A, July 2018