

GX21, GX19, and GX FF Cordless Electric Airless Sprayers

3A8429B

EN

For portable airless spraying of architectural paints and coatings. Not approved for use in explosive atmospheres or hazardous (classified) locations. For professional use only.

GX21 Cordless Models: 25T973, 25T967

FinishPro GX19 Models: 25U341, 25U855

GX FF Models: 25U466, 25U570

3000 psi (207 bar, 20.7 MPa) Maximum Working Pressure



Important Safety Instructions

Read all warnings and instructions in this manual and related manuals. Be familiar with the controls and the proper usage of the equipment. Save these instructions.

Related Manuals

312830 (SG3) Gun (GX21)

3A6285 Contractor PC Compact Gun (GX19, GX FF)

3A3172 Pump

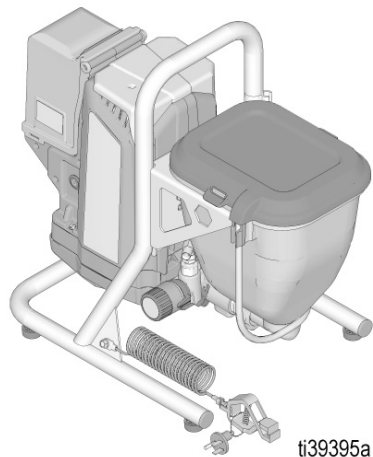
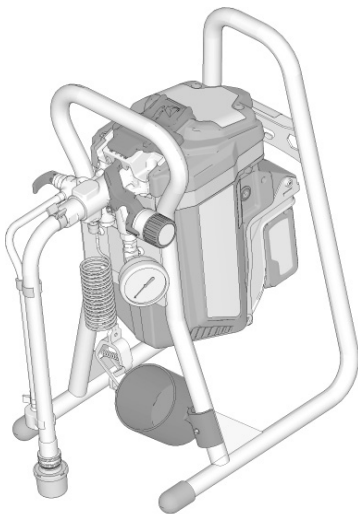

ti39395a







*Use only genuine Graco replacement parts.
The use of non-Graco replacement parts may void warranty.*

Contents

Models	3
Important Grounding Information	4
Warnings	5
Know Your Sprayer	8
Grounding Instructions	10
Setup	12
Battery Installation and Removal	13
Pressure Relief Procedure	14
Operation	15
Flush Storage Fluid	15
Fill Pump	18
Fill Gun and Hose	19
How to Spray	20
Spray Tip Installation	20
Spray	21
Adjust Pressure Control	22
Tip and Pressure Selection	22
Spray Techniques	23
Triggering Gun	23
Aiming Gun	24
Spray Pattern Quality	24
Clear Tip Clog	24
Cleanup	25
Power Flush	27
Hopper Flushing	29
Cleaning InstaClean™ Fluid Filter	31
Clean the Gun	31
Storage	32
Reference	33
Spray Tip Selection	33
Cleaning Fluid Compatibility	33
Quick Reference	34
Maintenance	35
Airless Hoses	35
Spray Tips	35
Pump Repair	35
Troubleshooting	38
Parts	42
Wiring Diagrams	48
Technical Specifications	49
Graco Standard Warranty	50
Graco Information	51

Models

	Region	Model	Hopper	Stand	Battery Voltage VDC	Charger Voltage VAC
	NA/CA	FinishPro GX19	25U341		60	120
	UK	GX21 Cordless		25T973	54	230
		GX FF	25U570			
	EMEA	GX21 Cordless		25T967	54	230
		GX FF	25U466			
	ANZ	FinishPro GX19	25U855		54	230

The GX21, GX19, and GX FF Electric Airless Sprayers are compatible with the following DEWALT FLEXVOLT 54V and 60V batteries:

- DCB606 - 60V/2ah (20V/6ah)
- DCB546 - 54V/2ah (18V/6ah)
- DCB609 - 60V/3ah (20V/9ah)
- DCB547 - 54V/3ah (18V/9ah)
- DCB548 - 54V/4ah (18V/12ah)
- DCB612 - 60V/4ah (20V/12ah)

Related DEWALT Manuals

Manual	Description	Region
N463494	DEWALT DCB118 Fast Charger Manual	USA/CA
N463510 N463511	DEWALT DCB118-QW Fast Charger Manual (Part 1 and 2)	EMEA
N501136	DEWALT DCB118-XE Fast Charger Manual	ANZ/AP



Important Grounding Information

Important Grounding Information

Before using your sprayer read this manual for complete instructions on proper use and safety warnings. The following information is intended to help you understand when to use the grounding wire and clamp provided with your sprayer.







Please read the information on the material container label to determine if it is oil-based or flammable. Ask for a Safety Data Sheet (SDS) from your supplier. The container label and SDS will explain the contents of the material and the specific precautions related to it.

Paints, coatings and clean-up materials generally fit into one of the following **3 basic types**:

Grounding Wire and Clamp Required?	Type of Material
No	WATER-BASED: The container label should indicate that the material can be cleaned up with soap and water.
Yes 	OIL-BASED: The container label should indicate that the material is COMBUSTIBLE and can be cleaned up with mineral spirits or non-flammable paint thinner. Use oil-based material outdoors or in a well-ventilated indoor area with a flow of fresh air. See the safety warnings in this manual. Follow Grounding Instructions , page 10, when using this type of material.
Yes 	FLAMMABLE: This type of material contains flammable solvents such as xylene, toluene, naphtha, MEK, lacquer thinner, acetone, denatured alcohol, and turpentine. The container label should indicate that this material is FLAMMABLE. Use flammable materials outdoors or in a well-ventilated area with a flow of fresh air. Follow Grounding Instructions , page 10, when using this type of material.

Warnings

The following warnings are for the setup, use, grounding, maintenance, and repair of this equipment. The exclamation point symbol alerts you to a general warning and the hazard symbols refer to procedure-specific risks. When these symbols appear in the body of this manual or on warning labels, refer back to these Warnings. Product-specific hazard symbols and warnings not covered in this section may appear throughout the body of this manual where applicable.

 WARNING	
 	<p>FIRE AND EXPLOSION HAZARD (GROUNDING)</p> <p>Oil-based and flammable materials can generate static electricity when sprayed or flushed. Static electricity creates a risk of fire or explosion in the presence of paint or solvent fumes. To help prevent fire and explosion when using oil-based or flammable materials:</p> <ul style="list-style-type: none"> • Connect the grounding wire and clamp to a true earth ground. • If there is static sparking or if you feel a shock, stop operation immediately. Do not use sprayer until you identify and correct the problem. • All parts of the spray system, including the pump, hose assembly, spray gun, and objects in and around the spray area shall be properly grounded to protect against static discharge and sparks. Use Graco conductive or grounded high-pressure airless paint sprayer hoses. Follow Grounding Instructions, page 10. • Verify that all containers and collection systems are grounded to prevent static discharge. Do not use pail liners unless they are anti-static or conductive.
   	<p>FIRE AND EXPLOSION HAZARD</p> <p>Flammable fumes, such as solvent and paint fumes, in work area can ignite or explode. To help prevent fire and explosion:</p> <ul style="list-style-type: none"> • Do not spray flammable or combustible materials near an open flame or sources of ignition such as cigarettes, motors, and electrical equipment. • Do not use a paint or a solvent containing halogenated hydrocarbons. • Do not spray flammable or combustible liquids in a confined area. • Keep spray area well-ventilated. Keep a good supply of fresh air moving through the area. • Keep pump assembly in a well-ventilated area at least 20 feet (6.1 m) from the spray area when spraying, flushing, cleaning, or servicing. Do not spray pump assembly. • Do not smoke in the spray area or spray where sparks or flame is present. • Do not operate light switches, engines, or similar spark producing products in the spray area. • Keep area clean and free of paint or solvent containers, rags, and other flammable materials. • Know the contents of the paints and solvents being sprayed. Read all Safety Data Sheets (SDSs) and container labels provided with the paints and solvents. Follow the paint and solvent manufacturer's safety instructions. • Keep a working fire extinguisher in the work area.

Warnings

WARNING



SKIN INJECTION HAZARD

High-pressure spray is able to inject toxins into the body and cause serious injury that can result in amputation. In the event that injection occurs, **get immediate surgical treatment.**



- Do not aim the gun at, or spray any person or animal.
- Keep hands and other body parts away from the discharge. For example, do not try to stop leaks with any part of the body.
- Always use the spray tip guard. Do not spray without spray tip guard in place.
- Use Graco spray tips.
- Use caution when cleaning and changing spray tips. In the case where the spray tip clogs while spraying, follow the **Pressure Relief Procedure** for turning off the unit and relieving the pressure before removing the spray tip to clean.
- Equipment maintains pressure after power is shut off. Do not leave the equipment energized or under pressure while unattended. Follow the **Pressure Relief Procedure** when the equipment is unattended or not in use, and before servicing, cleaning, or removing parts.
- Check hoses and parts for signs of damage. Replace any damaged hoses or parts.
- This system is capable of producing 3000 psi (207 bar, 20.7 MPa). Use Graco parts or accessories that are rated a minimum of 3000 psi (207 bar, 20.7 MPa).
- Always engage the trigger lock when not spraying. Verify the trigger lock is functioning properly.
- Verify that all connections are secure before operating the unit.
- Know how to stop the unit and bleed pressure quickly. Be thoroughly familiar with the controls.









EQUIPMENT MISUSE HAZARD

Misuse can cause death or serious injury.



- Always wear appropriate gloves, eye protection, and a respirator or mask when spraying.
- Do not operate or spray near children. Keep children away from equipment at all times.
- Do not overreach or stand on an unstable support. Keep effective footing and balance at all times.
- Stay alert and watch what you are doing.
- Do not operate the unit when fatigued or under the influence of drugs or alcohol.
- Do not kink or over-bend the hose.
- Do not expose the hose to temperatures or to pressures in excess of those specified by Graco.
- Do not use the hose as a strength member to pull or lift the equipment.
- Do not spray with a hose shorter than 25 feet.
- Always replace cracked, broken or missing parts immediately with genuine Graco parts. See **Parts**, page 42.
- Do not alter or modify equipment. Alterations or modifications may void agency approvals and create safety hazards.
- Use only in dry locations. Do not expose to water or rain.
- Use in well-lit areas.
- Make sure all equipment is rated and approved for the environment in which you are using it.
- Do not operate or clean sprayer with the battery shield open.

WARNING

	<p>PRESSURIZED ALUMINUM PARTS HAZARD</p> <p>Use of fluids that are incompatible with aluminum in pressurized equipment can cause serious chemical reaction and equipment rupture. Failure to follow this warning can result in death, serious injury, or property damage.</p> <ul style="list-style-type: none"> • Do not use 1,1,1-trichloroethane, methylene chloride, other halogenated hydrocarbon solvents or fluids containing such solvents. • Do not use chlorine bleach. • Many other fluids may contain chemicals that can react with aluminum. Contact your material supplier for compatibility.
 	<p>BATTERY AND CHARGER COMPATIBILITY HAZARD</p> <ul style="list-style-type: none"> • Only use DEWALT brand 54V Max or 60V Max batteries and battery chargers with this tool. • READ ALL INSTRUCTIONS included with this tool regarding the safety and usage of DEWALT batteries and battery chargers. • Do not wash or spray down battery. • Do not clean the battery with anything other than a cloth moistened with water.
 	<p>MOVING PARTS HAZARD</p> <p>Moving parts can pinch, cut, or amputate fingers and other body parts.</p> <ul style="list-style-type: none"> • Keep clear of moving parts. • Do not operate equipment with protective guards or covers removed. • Equipment can start without warning. Before checking, moving, or servicing equipment, follow the Pressure Relief Procedure and disconnect all power sources.
	<p>TOXIC FLUID OR FUMES HAZARD</p> <p>Toxic fluids or fumes can cause serious injury or death if splashed in the eyes or on skin, inhaled, or swallowed.</p> <ul style="list-style-type: none"> • Read Safety Data Sheets (SDSs) to know the specific hazards of the fluids you are using. • Store hazardous fluid in approved containers, and dispose of it according to applicable guidelines.
	<p>PERSONAL PROTECTIVE EQUIPMENT</p> <p>Wear appropriate protective equipment when in the work area to help prevent serious injury, including eye injury, hearing loss, inhalation of toxic fumes, and burns. Protective equipment includes but is not limited to:</p> <ul style="list-style-type: none"> • Protective eyewear, and hearing protection. • Respirators, protective clothing, and gloves as recommended by the fluid and solvent manufacturer.

Know Your Sprayer

Know Your Sprayer GX21 Component Identification

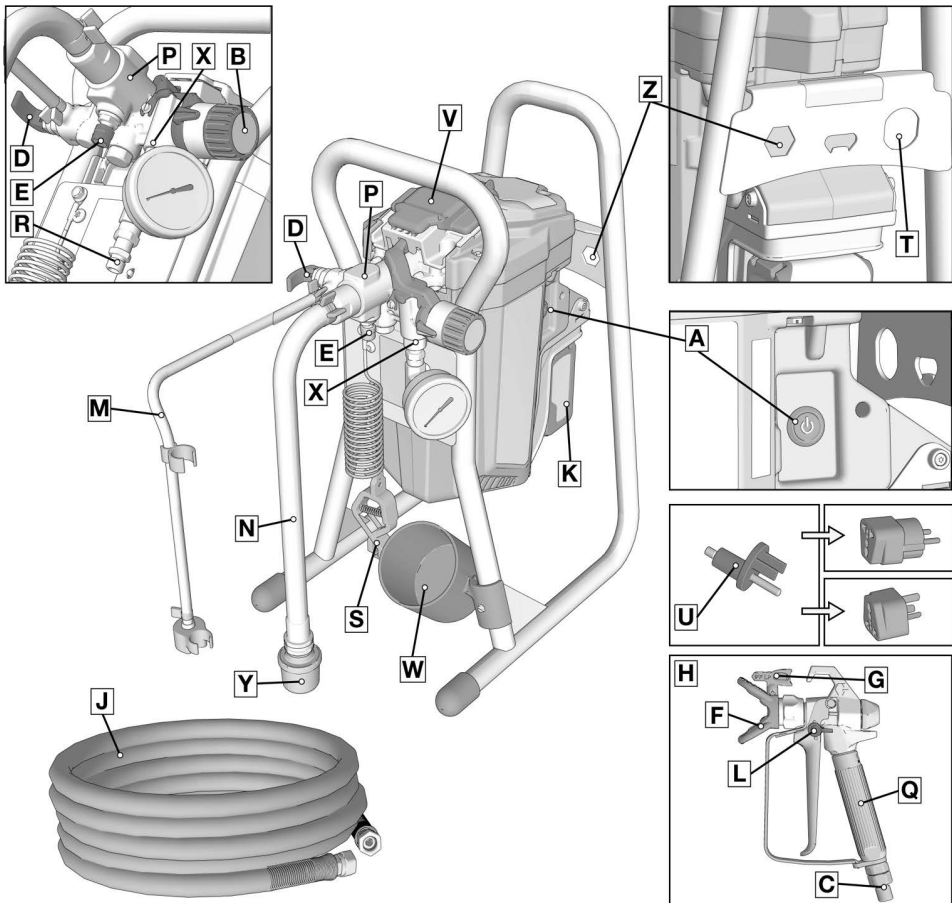

139387a

A	ON/OFF Switch
B	Pressure Control Knob
C	Gun Fluid Inlet Fitting
D	Prime Valve
E	Push Prime Button
F	Tip Guard
G	Reversible Spray Tip
H	Airless Spray Gun
J	Airless Hose
K	Battery
L	Gun Trigger Lock
M	Drain Tube (with Diffuser)
N	Fluid Intake (Suction) Tube
P	ProXChange™ Pump (behind easy access door)

Q	Gun Fluid Filter (inside handle)
R	Fluid Outlet Fitting (airless hose connection)
S	Grounding Wire with Clamp
T	Inlet Valve Removal Tool
U	Ground Adapter
V	Easy Access Door with Cover
W	Suction/Drain Tube Cup
X	InstaClean™ Fluid Filter (inside fluid outlet)
Y	Inlet Strainer
Z	Pump Removal Tool
	Model/Serial Tag (Not shown, located on bottom of unit.)

See **Quick Reference**, page 34 for more information.

GX19 and GX FF Component Identification

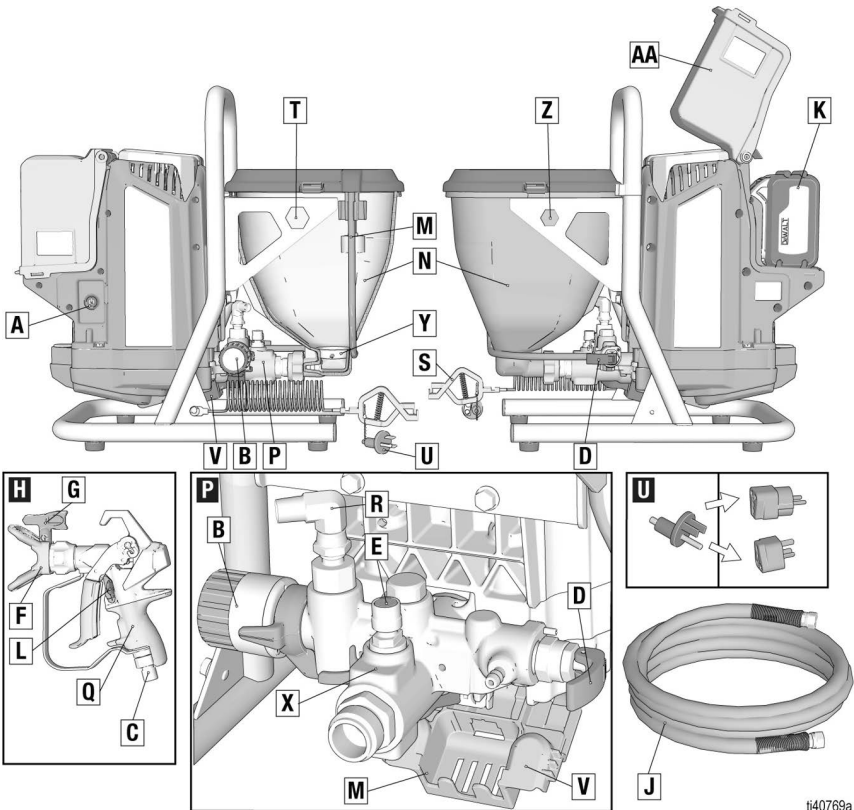

t40769a

A	ON/OFF Switch
B	Pressure Control Knob
C	Gun Fluid Inlet Fitting
D	Prime Valve
E	Push Prime Button
F	Tip Guard
G	Reversible Spray Tip
H	Airless Spray Gun
J	Airless Hose
K	Battery
L	Gun Trigger Lock
M	Drain Tube (with Diffuser)
N	Hopper
P	ProXChange™ Pump
Q	Gun Fluid Filter (inside handle)

R	Fluid Outlet Fitting (airless hose connection)
S	Ground Wire with Clamp
T	Inlet Valve Removal Tool
U	Ground Adapter
V	Easy Access Door
X	InstaClean™ Fluid Filter (inside fluid outlet)
Y	Inlet Strainer, Inside Hopper (not shown)
Z	Pump Removal Tool
AA	Battery Shroud
	Model/Serial Tag (Not shown, located on frame)
See Quick Reference , page 34 for more information.	

Grounding Instructions

Grounding Instructions (Oil-based and flammable materials)



The equipment must be grounded to reduce the risk of static sparking. A static spark can cause fumes to ignite or explode. A good ground provides an escape wire for the electric current.

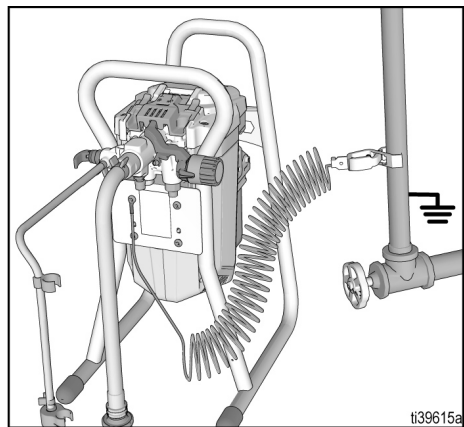

The sprayer is equipped with a grounding wire and clamp. The clamp must be connected to a true earth ground when spraying or flushing oil-based or flammable materials.

A water pipe can be used as a true earth ground. Connect the grounding wire and clamp to a metal water pipe.

A properly grounded electrical outlet can also be used as a true earth ground. Use the provided outlet adapter.

Plug the adapter in to a grounded outlet. Connect the grounding wire and clamp to the metal stud on the adapter. If the ground wire is not long enough to reach a grounded electrical outlet, use a 3-wire grounded extension cord between the adapter and outlet.

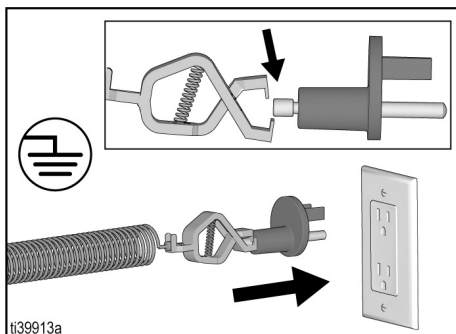

Fluid hoses: Use only electrically conductive hoses with a maximum of 300 ft. (91 m) combined hose length to ensure grounding continuity.

Spray gun: Grounded through connection to a properly grounded fluid hose and pump.

Grounding Instructions

Pails

Solvent and oil-based fluids: follow local codes and regulations. Use only conductive metal pails, placed on a grounded surface such as concrete.

Do not place pail on a non-conductive surface such as paper or cardboard which interrupts grounding continuity.



Always ground a metal pail: connect a ground wire to the pail. Clamp one end to the pail and the other end to a true earth ground such as a water pipe.

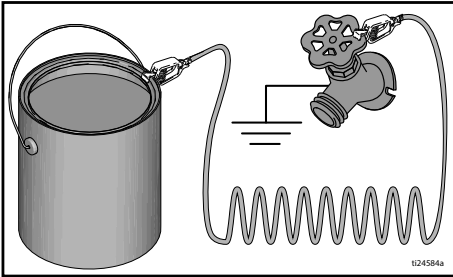

To maintain ground continuity when sprayer is flushed or pressure is relieved: hold metal part of spray gun firmly to the side of a grounded metal pail then trigger the gun.

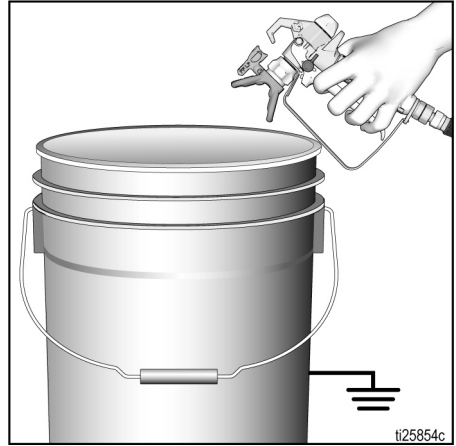

t25854c

Setup

Setup

When unpacking sprayer for the first time or after long term storage perform setup procedure.

1. Connect Graco airless hose to fluid outlet. Use wrench to tighten securely.

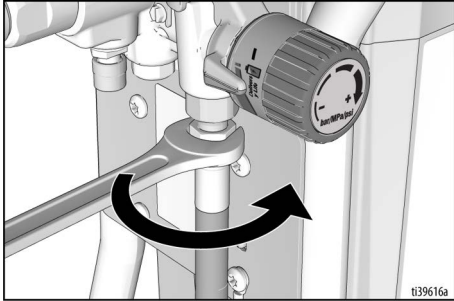

2. Connect other end of hose to gun.

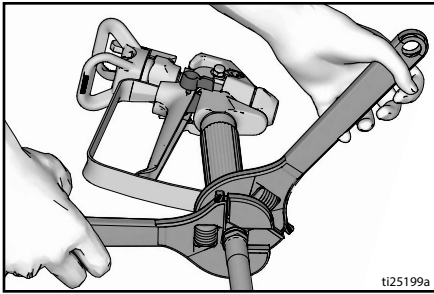

3. Use wrenches to tighten securely. If hose is already connected, make sure connections are tight.
4. Engage trigger lock.

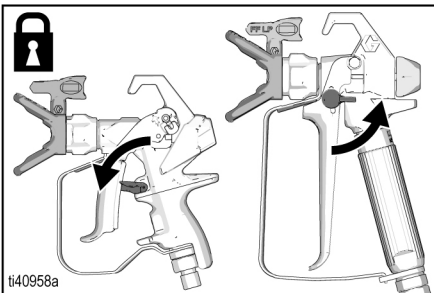

5. Remove tip guard. Do not lose the seal.

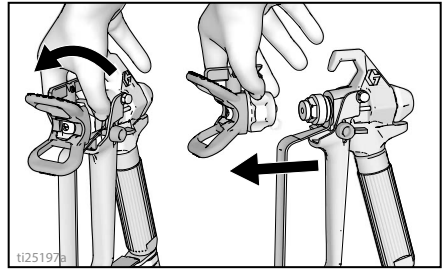

6. Turn Pressure Control Knob all the way left (counter-clockwise) to minimum pressure.

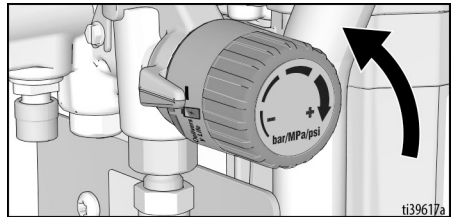

7. When unpacking sprayer for the first time remove packaging materials from inlet strainer. After long term storage check inlet strainer for clogs and debris.

Strain the Paint

Previously opened paint may contain dried paint or other debris. To avoid priming problems and spray tip clogs it is recommended to strain the paint before using. Paint strainers are available where paint is sold. Stretch a paint strainer over a clean pail and pour the paint through the strainer to capture any dried paint and debris before spraying.



Battery Installation and Removal

Always start with a fully charged battery. Do not splash or immerse battery or charger in water. See battery and charger information shipped with the sprayer.

Remove and install battery into the sprayer as follows:

1. Remove the used battery, if in place.
2. Install battery by aligning the battery pack with the rails inside the sprayer and sliding it in until the battery pack is firmly seated. Ensure that it does not disengage.

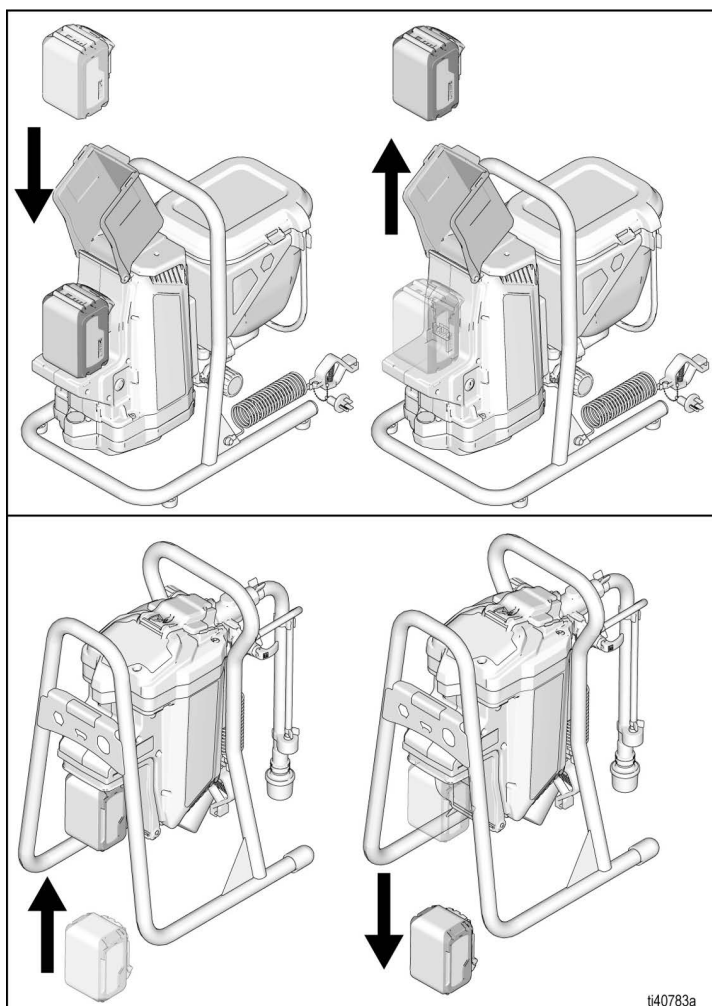
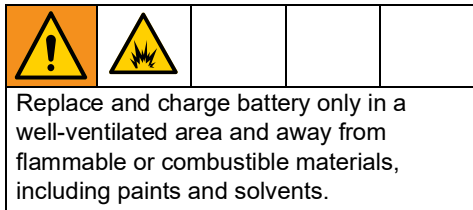

ti40783a

Pressure Relief Procedure

Pressure Relief Procedure



Follow the Pressure Relief Procedure whenever you see this symbol.

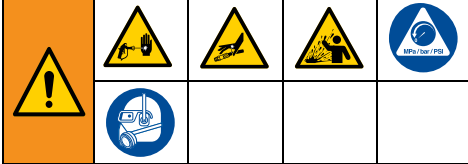

This equipment stays pressurized until pressure is manually relieved. To help prevent serious injury from pressurized fluid, such as skin injection or splashed fluid, follow the **Pressure Relief Procedure** whenever sprayer is stopped and before sprayer is cleaned or checked, and before equipment is serviced.

1. Engage the trigger lock. Always engage the trigger lock when sprayer is stopped to prevent the gun from being triggered accidentally.

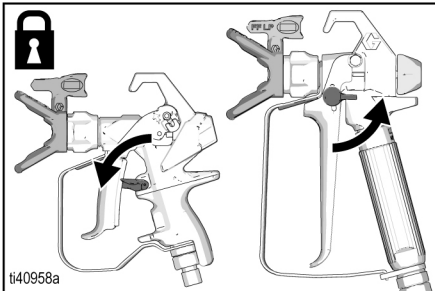

2. Turn ON/OFF switch to the **OFF** position. Power button is not illuminated when power is OFF.

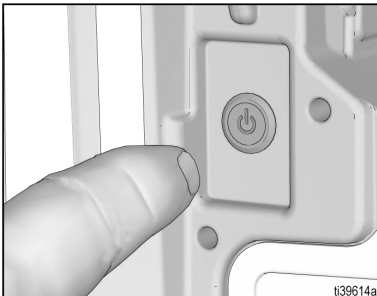

3. Turn pressure control to lowest setting.

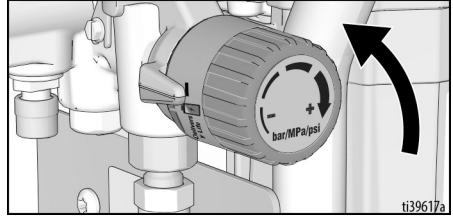

4. Hold the gun firmly to a pail, point gun into pail. Disengage the trigger lock and trigger the gun to relieve pressure.

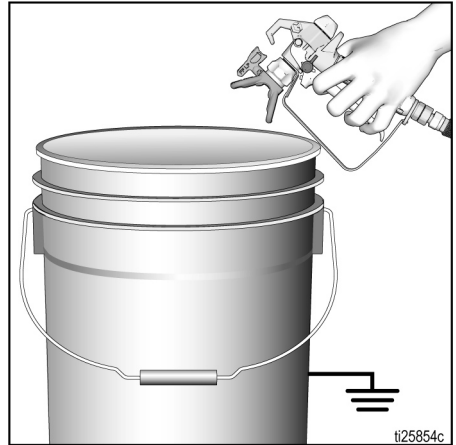

5. Engage the trigger lock.
6. Put drain tube into a pail and place Prime/Spray valve in PRIME position (drain) to relieve pressure.
7. If you suspect the spray tip or hose is clogged or that pressure has not been fully relieved:
 - a. **VERY SLOWLY** loosen the spray tip guard retaining nut or the hose end coupling to relieve pressure gradually.
 - b. Loosen the nut or coupling completely.
 - c. Clear airless hose or spray tip obstruction.

Operation

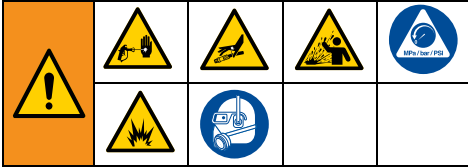

Prime/Spray Valve

The Prime/Spray Valve uses a lever that is flipped between the PRIME and SPRAY position.

SPRAY Position

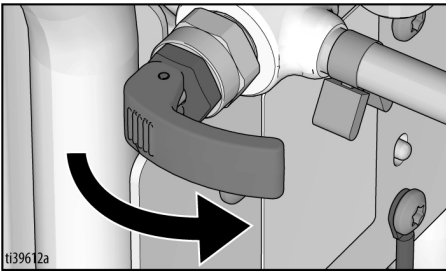

PRIME Position

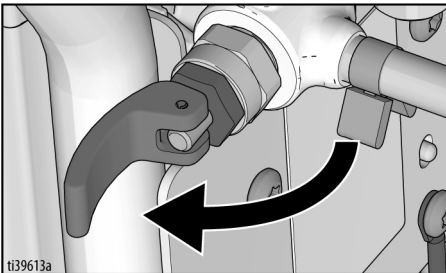

Flush Storage Fluid

This sprayer arrives from the factory with a small amount of test material in the system. **It is important that you flush this material from the sprayer before using it for the first time.** See **Cleaning Fluid Compatibility**, page 33 and **Quick Reference**, page 34 for additional information.

1. Perform **Pressure Relief Procedure**, page 14.
2. Make certain ON/OFF switch is **OFF**. Power button is not illuminated when OFF.

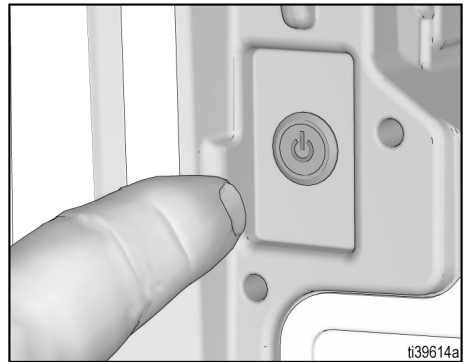

For Stand Models

- a. Separate drain tube (smaller) from suction tube (larger).

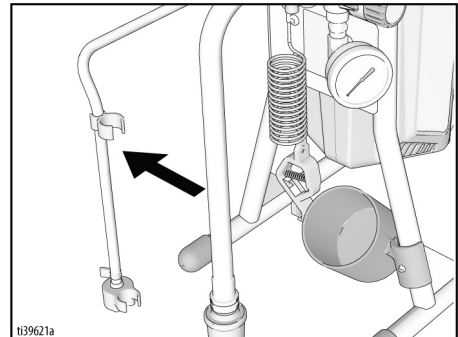

Operation

- b. Place drain tube in a grounded waste pail.

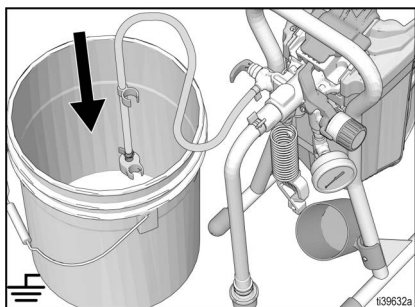

- c. Submerge suction tube in a grounded pail partially filled with water or flushing fluid. When flushing with oil-based or flammable materials, follow **Grounding Instructions**, page 10.

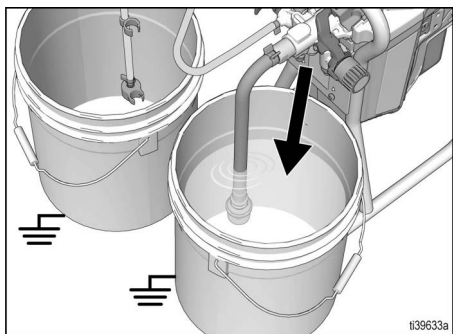

- b. While holding the drain tube retainer with drain tube parallel to the top of a waste pail, twist retainer over the lip of the pail. Drain tube should now be inside the waste pail.

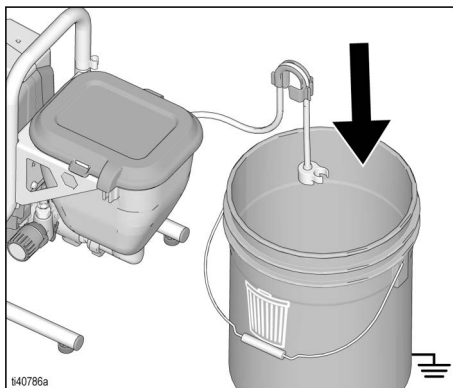

- c. Pour approximately two quarts (two liters) of water or flushing fluid into the hopper. When using oil-based or flammable material, follow **Grounding Instructions**, page 10.

3. Place Prime/Spray valve in PRIME position.

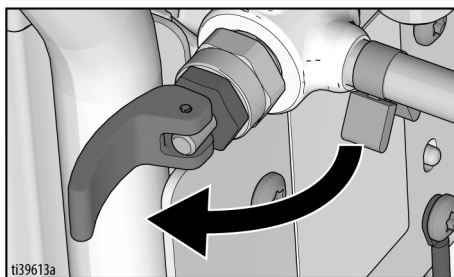

For Hopper Models

- a. Lift drain tube with retainer off the hopper.

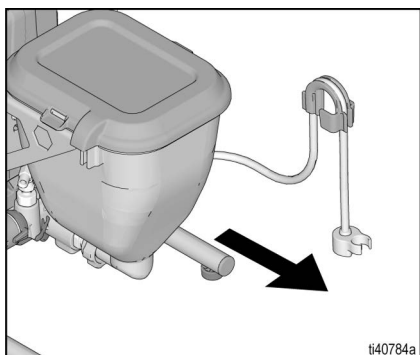

4. Install battery. See **Battery Installation and Removal**, page 13.

5. Press PushPrime button twice to loosen inlet ball.

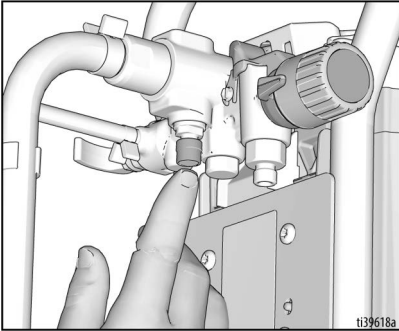

6. Align setting indicator with low setting on Pressure Control Knob.

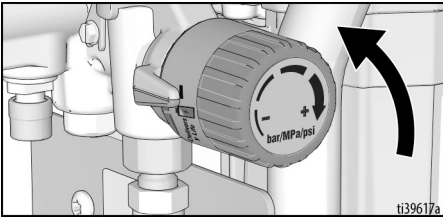

7. Turn ON/OFF switch to **ON** position. Power button is illuminated when ON.

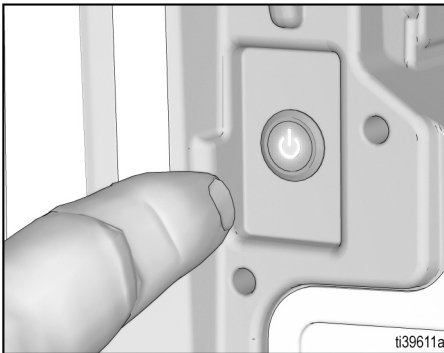

8. Increase pressure 1/2 turn to start motor. Allow paint or other material to circulate through sprayer until material flows out the drain tube.

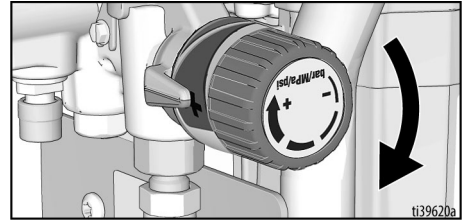

9. When sprayer starts pumping, flushing fluid and air bubbles will be purged from system. Allow fluid to flow out of drain tube into waste pail for 30 to 60 seconds.

10. Turn ON/OFF switch to **OFF** position. Power button is not illuminated when OFF.

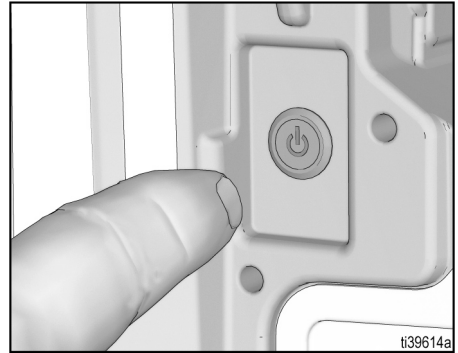

High-pressure spray is able to inject fluid into the body and cause serious bodily injury. Do not stop leaks with hand or rag.

11. Inspect for leaks. If leaks occur, perform **Pressure Relief Procedure**, page 14, then tighten all fittings. If there are no leaks continue with the next step.

Operation

Fill Pump

For Stand Models

1. Move suction tube to paint pail and submerge suction tube in paint. When spraying oil-based or flammable materials, follow **Grounding Instructions**, page 10.

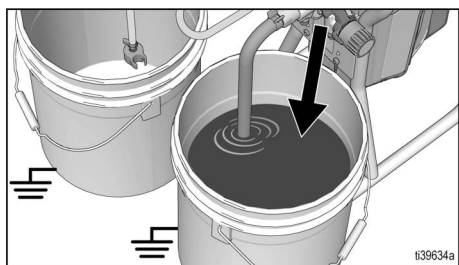

2. Press ON/OFF switch to **ON** position. Button is illuminated when power is ON.
3. Wait to see paint coming out of the drain tube.

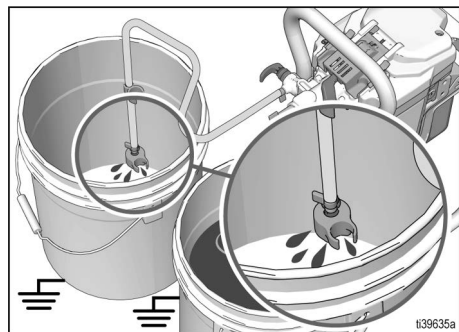

4. Press ON/OFF switch to **OFF** position. Button is not illuminated when power is OFF.

NOTE: Some fluids may prime faster if the ON/OFF switch is momentarily turned off so the pump can slow and stop. Turn ON/OFF switch on and off several times if necessary.

For Hopper Models

1. Add paint to hopper. When spraying oil-based or flammable materials, follow **Grounding Instructions**, page 10.

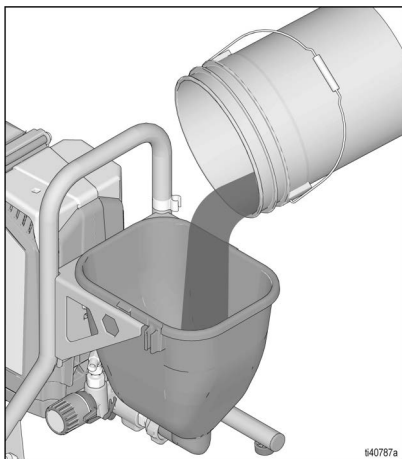

2. Press ON/OFF switch to **ON** position. Button is illuminated when power is ON.
3. Wait to see paint coming out of the drain tube.

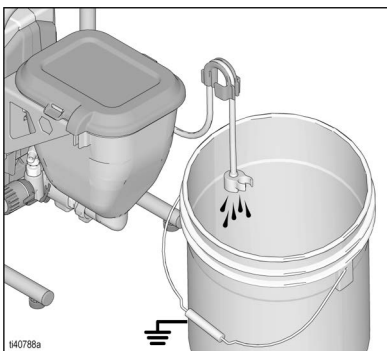

4. Press ON/OFF switch to **OFF** position. Button is not illuminated when power is OFF.

NOTE: Some fluids may prime faster if the ON/OFF switch is momentarily turned off so the pump can slow and stop. Turn ON/OFF switch on and off several times if necessary.

Fill Gun and Hose

1. Hold gun against waste pail. Point gun into waste pail.
 - a. Disengage trigger lock.
 - b. Pull and hold gun trigger.
 - c. Turn Prime/Spray valve to SPRAY position.
 - d. Press ON/OFF switch to **ON** position. Button is illuminated when power is ON.

2. Trigger gun into waste pail until only paint comes out of the gun.
3. Release trigger. Engage trigger lock.
4. Transfer drain tube to paint pail and clip to suction tube. On hopper models, clip drain tube to hopper.

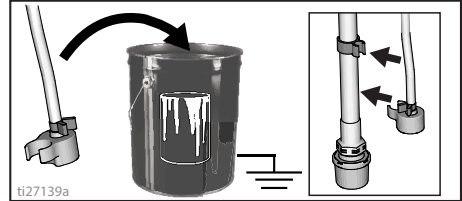

NOTE: When motor stops sprayer is ready to paint. If motor continues to run sprayer is not properly primed, repeat **Fill Pump** and **Fill Gun and Hose**.

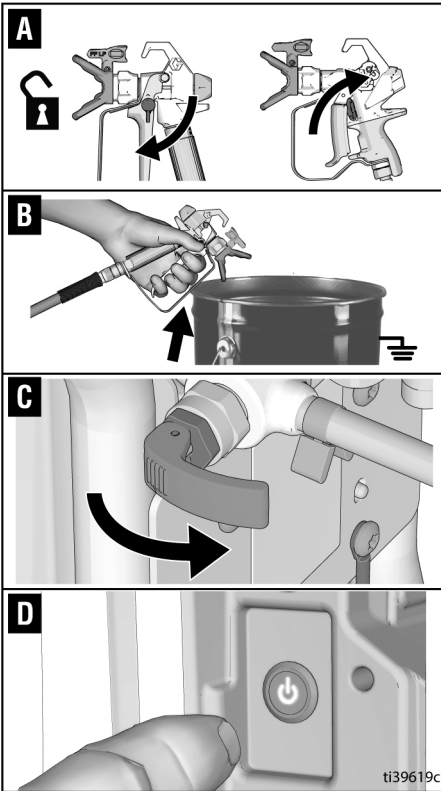

How to Spray

How to Spray

Spray Tip Installation

				
<p>To avoid serious injury from skin injection, do not put your hand in front of the Spray Tip when installing or removing the Spray Tip or Spray Tip Guard.</p>				

To prevent spray tip leaks make certain spray tip and tip guard are installed properly.

1. Perform **Pressure Relief Procedure**, page 14.
2. Engage trigger lock.
3. Verify spray tip and tip guard parts are assembled in the order shown.

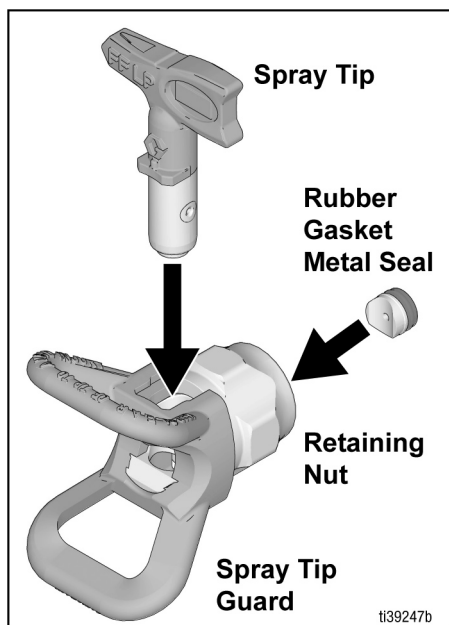

- a. Use spray tip to align gasket and seal in the tip guard.

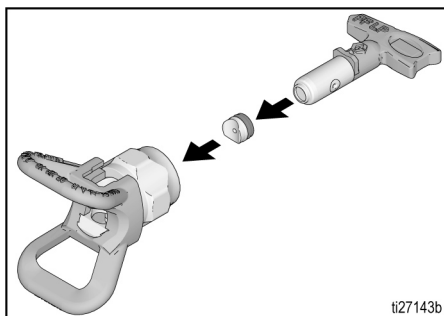

- b. Spray tip must be pushed all the way into the tip guard. Turn spray tip to push down.

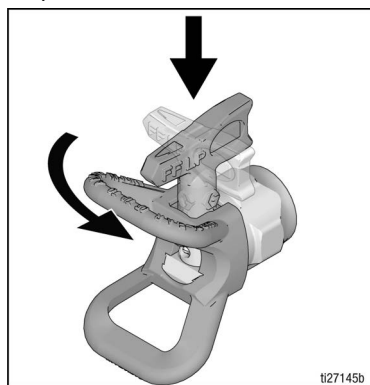

- c. Turn the arrow shaped handle on the spray tip forward to the spray position.
4. Screw spray tip assembly onto the gun and tighten.

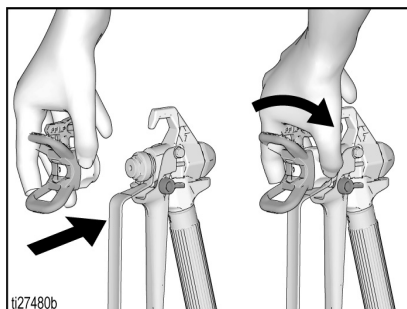

Spray

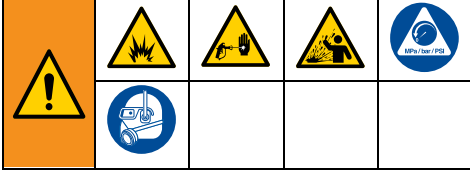

When a RAC X™ FF LP Fine Finish Low Pressure reversible spray tip is used, spraying pressure can be lowered. Spraying at a lower pressure results in less overspray and reduces spray tip wear. Adjust the sprayer pressure to minimize overspray.

NOTE: If spraying oil-based or flammable material, follow **Grounding Instructions**, page 10.

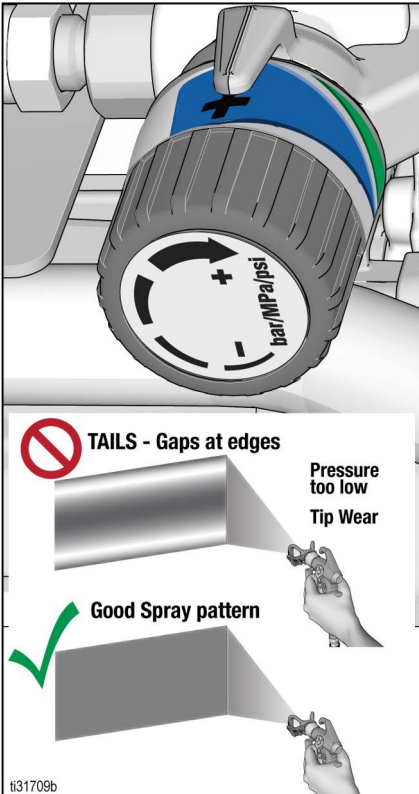

Atomized, evenly distributed fan pattern

Tails

How to Spray

Adjust Pressure Control

The pressure control knob allows for infinite pressure adjustment. To reduce overspray, always start at the lowest pressure setting and increase pressure to the minimum setting that results in an acceptable spray pattern.

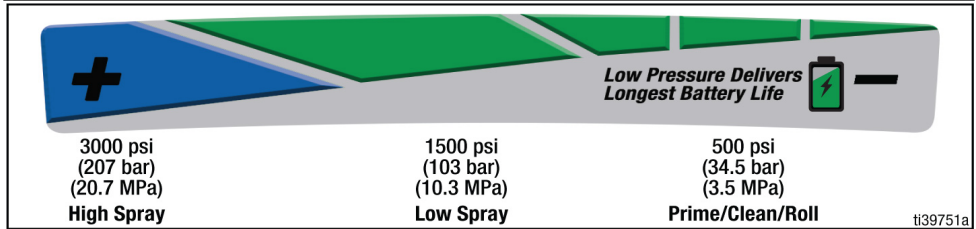
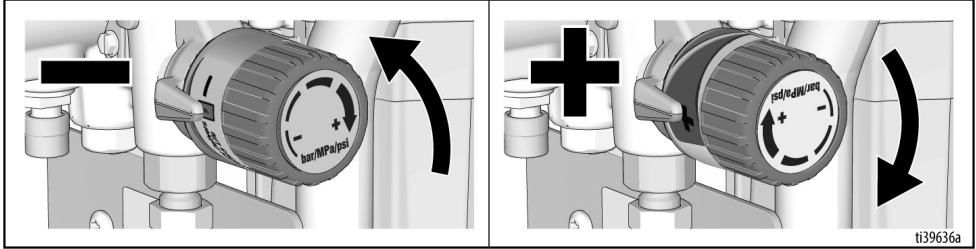

To select pressure, align symbol on pressure control knob with setting indicator on sprayer.

Tip and Pressure Selection

See table for recommended spray pressure for your material. Refer to paint (material) can for manufacturer's recommendations.

Maximum tip hole sizes supported by the sprayer:

- GX21: 0.021 in. (0.53 mm), GX19 and GX FF: 0.019 in. (0.48 mm).

	Coatings				
	Stains	Enamels	Primers	Interior Paints	Exterior Paints
Spray Pressure Setting	Low Spray	Low Spray	High Spray	High Spray	High Spray
Tip Hole Size					
0.011 in. (0.28 mm)	✓				
0.013 in. (0.33 mm)	✓	✓	✓	✓	
0.015 in. (0.38 mm)		✓	✓	✓	✓
0.017 in. (0.43 mm)			✓	✓	✓
0.019 in. (0.48 mm)					✓
0.021 in. (0.53 mm)					✓

Fine Finish Tips

Fine Finish tips have an additional orifice that provides a finer atomization of the material.

Size	Coatings				
	Polyurethane	Lacquer	Sanding Sealer	Enamels	Latex
Spray Pressure Setting	Low Spray	Low Spray	Low Spray	High Spray	High Spray
0.008 in. (0.20 mm)	✓	✓	✓		
0.010 in. (0.25 mm)	✓	✓	✓		
0.012 in. (0.31 mm)				✓	
0.014 in. (0.36 mm)					✓
0.016 in. (0.41 mm)					✓

Spray Techniques

Use a piece of scrap cardboard to practice these basic spraying techniques before you begin spraying the surface.

- Hold gun 12 in. (30 cm) from surface and aim straight at surface. Tilting gun to direct spray at angle causes an uneven finish.

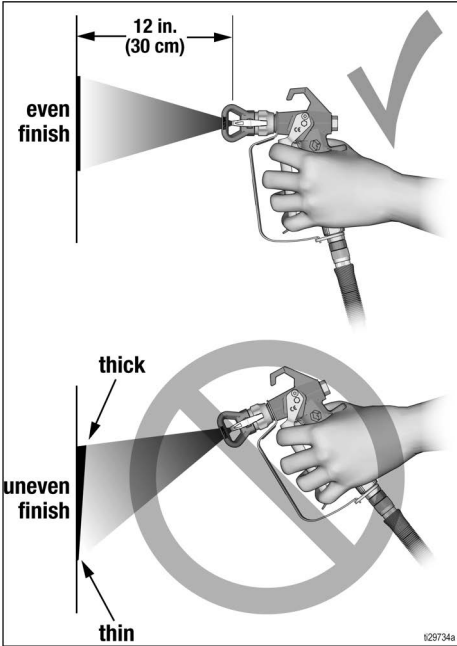

- Flex wrist to keep gun pointed straight. Fanning gun to direct spray at angle causes uneven finish.

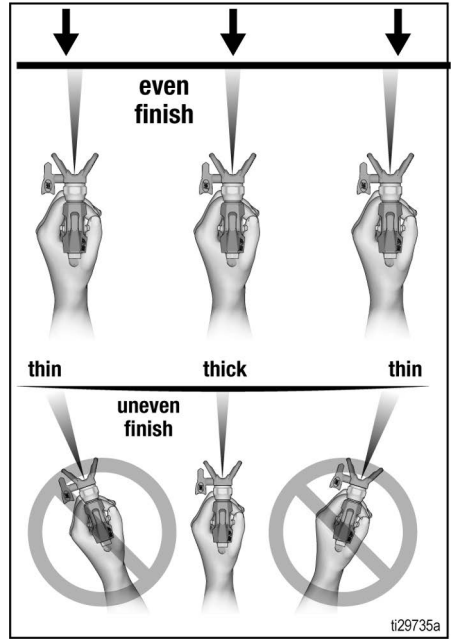

Triggering Gun

Pull trigger after starting stroke. Release trigger before end of stroke. Gun must be moving when trigger is pulled and released.

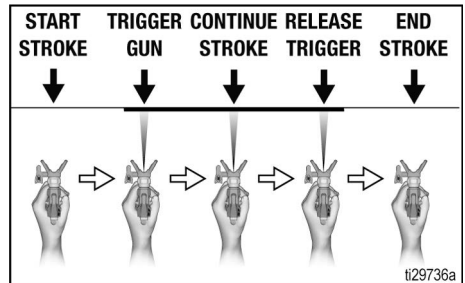

How to Spray

Aiming Gun

Aim center of spray of gun at bottom edge of previous stroke, overlapping each stroke by half.

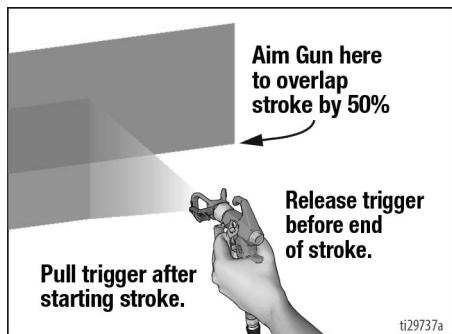

Spray Pattern Quality

A good spray pattern is evenly distributed as it hits the surface.

- Spray should be atomized (evenly distributed, no gaps at edges).

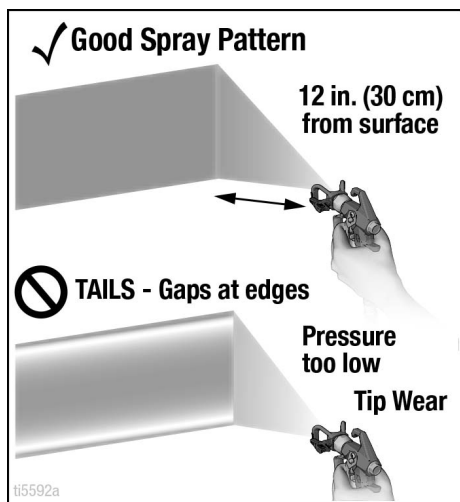

If tails persist when spraying at the highest spray pressure:

- Spray tip may be worn. See **Spray Tip Selection**, page 33.
- A smaller spray tip may be needed.

- Material may need to be thinned. If material needs to be thinned follow manufacturer's recommendations.

Clear Tip Clog

In the event that particles or debris clog the spray tip, this sprayer is designed with a reversible spray tip that quickly and easily clears the particles without disassembling the sprayer.

See **Strain the Paint**, page 12 for additional information.

1. Release trigger. Engage trigger lock. Rotate spray tip to unclog position. Disengage trigger lock. Trigger gun at waste area to clear clog.

Unclog

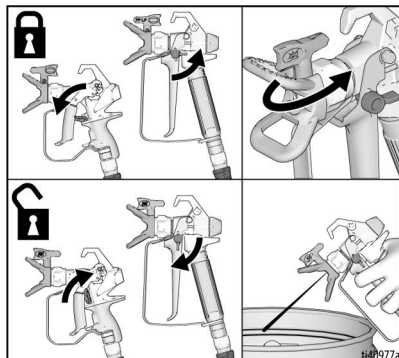

2. Engage trigger lock. Rotate spray tip back to spray position. Disengage trigger lock and continue spraying.

Spray

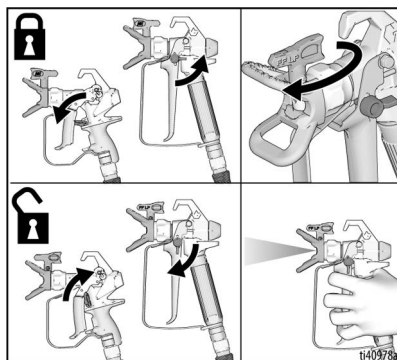

Cleanup

Cleaning the sprayer after each use results in a trouble free start up the next time the sprayer is used.

- For long term storage refer to **Storage**, page 32.
- See **Cleaning Fluid Compatibility**, page 33 and **Quick Reference**, page 34.

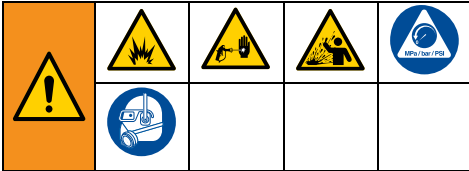

To avoid serious injury from fire and explosion when using oil-based or flammable materials:

- Do not spray solvents through the spray tip. Always remove tip guard and spray tip before flushing. Clean tip guard and spray tip in a bucket of compatible solvent.
- Clean in a well-ventilated area. Keep a good supply of fresh air moving through the area.
- When flushing with solvents, always ground the sprayer and waste container.

Cleaning From a Pail (Stand Models)

Pail flushing only works with models that have a suction tube.

1. When using oil-based or flammable material, follow **Grounding Instructions**, page 10.
2. Perform **Pressure Relief Procedure**, page 14.
3. Remove tip guard and spray tip. For additional information, see **Clean the Gun**, page 31

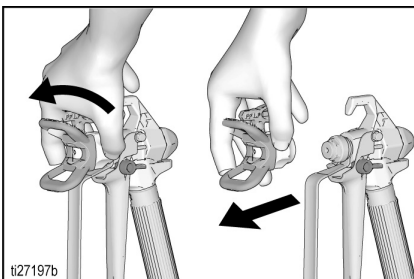

4. Remove suction tube and drain tube from paint, wipe excess paint off outside.

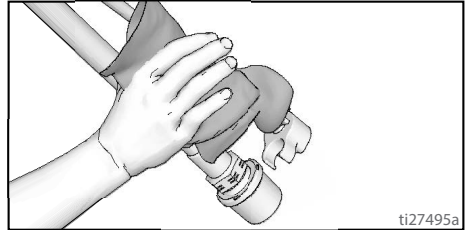

5. Separate drain tube (smaller) from suction tube (larger).

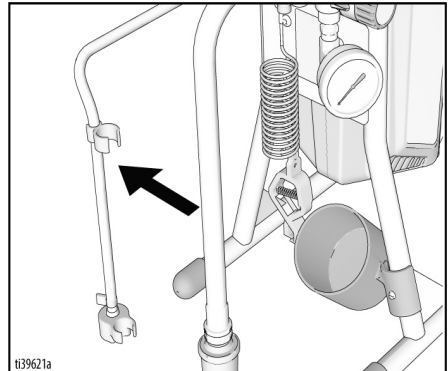

6. Place empty waste and flushing fluid pails side by side.
7. Place suction tube in flushing fluid. See **Cleaning Fluid Compatibility**, page 33, for appropriate flushing fluid to use. Place drain tube in waste pail.

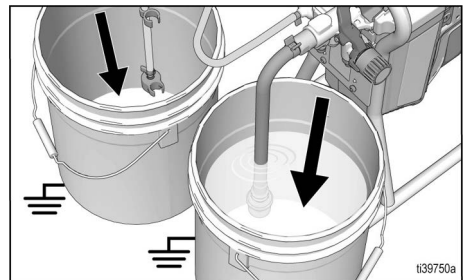

Cleanup

8. Turn Pressure Control Knob to the Prime/Clean setting (the lowest setting at which the pump will run).

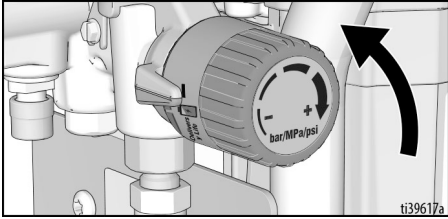

9. Place Prime/Spray valve in PRIME position.
10. Press ON/OFF switch to power **ON**. Button is illuminated when ON.
11. Flush until approximately 1/3 of the flushing fluid is emptied from the pail.
12. Press ON/OFF switch to power **OFF**. Button is not illuminated when OFF.

NOTE: Step 13 is for returning paint in airless paint hose to paint pail. One 50 ft (15 m) hose holds approximately 1 quart (1 liter) of paint.

13. To recover paint in hose:
- Hold gun firmly
 - Point gun into paint pail.
 - Disengage trigger lock.
 - Pull and hold gun trigger.
 - Place Prime/Spray valve in **SPRAY** position.

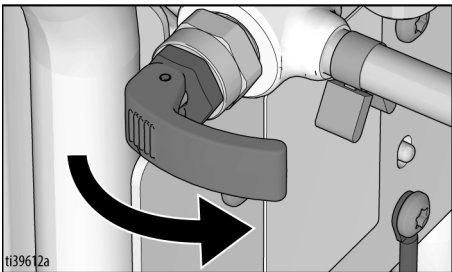

- f. Press ON/OFF switch to power **ON**. Button is illuminated when ON.
- g. Continue to hold gun trigger until you see paint diluted with flushing fluid starting to come out of gun.
14. While continuing to trigger gun, quickly move gun to redirect spray into a grounded waste pail. Continue triggering

gun into waste pail until flushing fluid dispensed from gun is relatively clear.

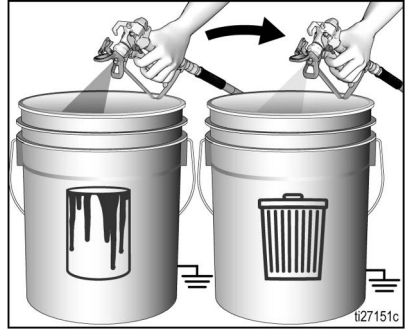

15. Stop triggering gun. Engage the trigger lock.

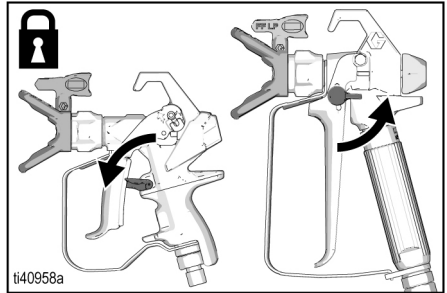

16. Place Prime/Spray valve in PRIME position.

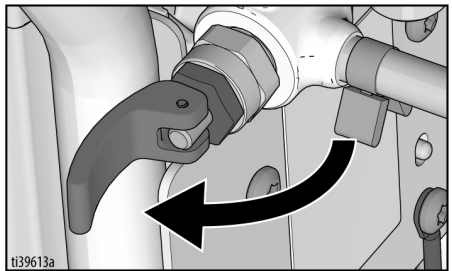

17. Press ON/OFF switch to power **OFF**. Button is not illuminated when OFF.
18. Clean filter. See **Cleaning InstaClean™ Fluid Filter**, page 31.
19. Fill unit with Pump Armor™ fluid. See **Storage**, page 32.
20. Remove battery.

Power Flush

(GX21, Water-Based Materials Only)

Power flushing is a faster method of flushing. It can only be used after spraying water-based materials.

1. Perform **Pressure Relief Procedure**, page 14.
2. Remove spray tip and tip guard assembly from gun and place in waste pail. For additional information, see **Clean the Gun**, page 31
3. Place empty waste and paint pails side by side.

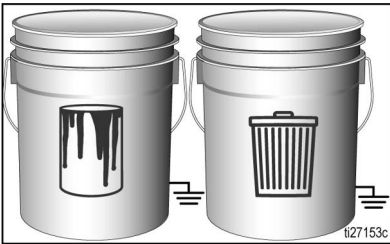

4. Lift suction tube and drain tube from paint pail. Let paint drain into the pail.
5. Place suction and drain tube in waste pail.
6. Turn Pressure Control knob to the Prime/Clean setting (lowest setting that the pump will run).

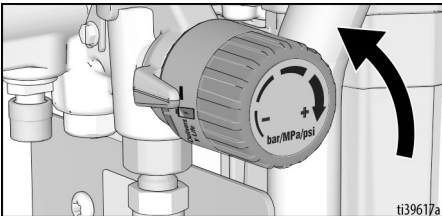

7. Screw power flush attachment valve to garden hose. Close valve.

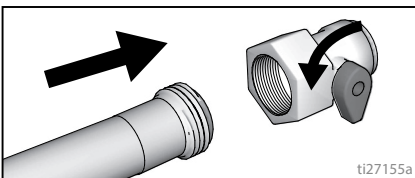

8. Turn on water. Open valve. Rinse paint off suction tube, drain tube and inlet strainer then close valve.

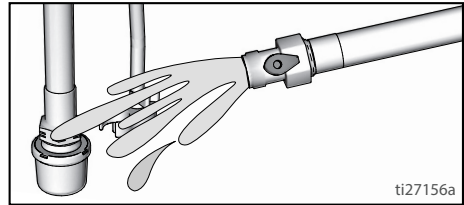

9. Unscrew inlet strainer from suction tube. Place inlet strainer in waste pail.

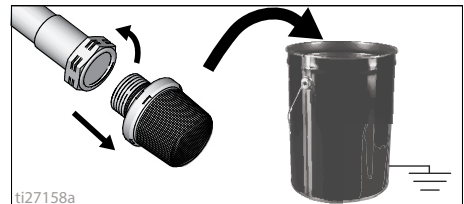

10. Connect garden hose to suction tube with Power Flush attachment valve. Leave drain tube in waste pail.

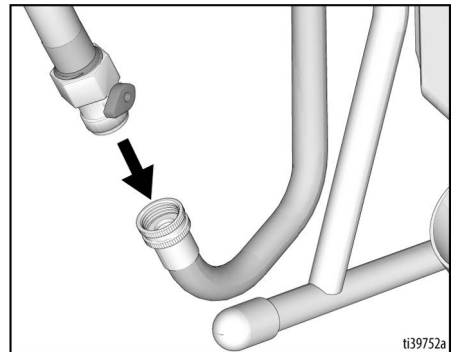

11. Press ON/OFF switch to power **ON**. Power button is illuminated when ON.

Cleanup

12. Open Power flush attachment valve.

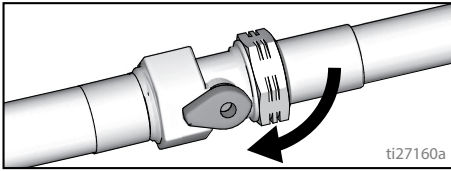

13. Circulate water through sprayer, into waste pail, for 20 seconds.

14. Press ON/OFF switch to power **OFF**. Power button is not illuminated when OFF.

NOTE: Step 15 is for returning paint in hose to paint pail. One 50 ft (15 m) hose holds approximately 1 quart (1 liter) of paint.

15. To recover paint in hose:

- Hold gun firmly.
- Point gun into paint pail.
- Disengage trigger lock.
- Pull and hold gun trigger.
- Place Prime/Spray valve in **SPRAY** position.

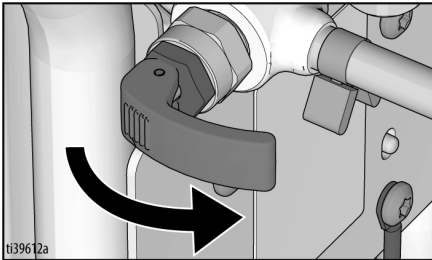

- Press ON/OFF switch to power **ON**. Power button is illuminated when ON.
- Continue to hold gun trigger until you see paint diluted with flushing fluid starting to come out of gun.

16. While continuing to trigger gun, quickly move gun to redirect spray into waste pail. Continue triggering gun into waste pail until flushing fluid dispensed from gun is relatively clear.

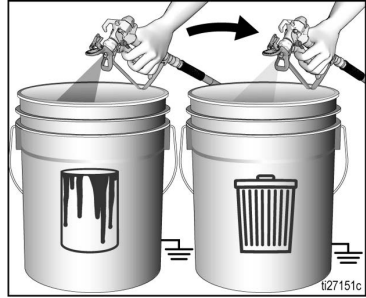

17. Turn Pressure Control Knob to the Prime/Clean setting.

18. Stop triggering gun. Engage the trigger lock.

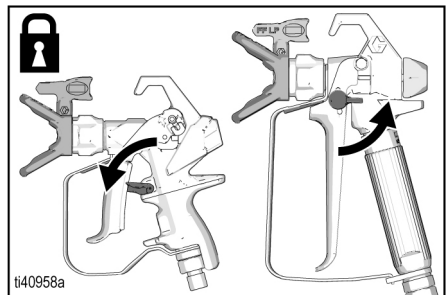

19. Place Prime/Spray valve in **PRIME** position.

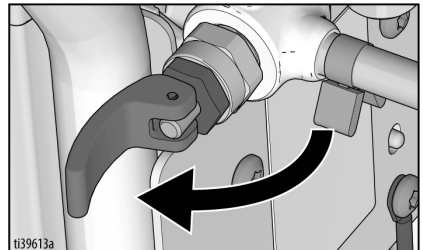

20. Press ON/OFF switch to power **OFF**. Button is not illuminated when OFF.

21. On sprayers with a filter, see **Cleaning InstaClean™ Fluid Filter**, page 31.

22. Fill unit with Pump Armor™ storage fluid. See **Storage**, page 32.

23. Remove battery.

Hopper Flushing

(Hopper Models Only)

See **Cleaning Fluid Compatibility**, page 33. When using oil-based or flammable material, follow **Grounding Instructions**, page 10.

1. Perform **Pressure Relief Procedure**, page 14.
2. Pour any remaining material out of the hopper.
3. Remove tip guard and Spray Tip. For additional information, see **Clean the Gun**, page 31.

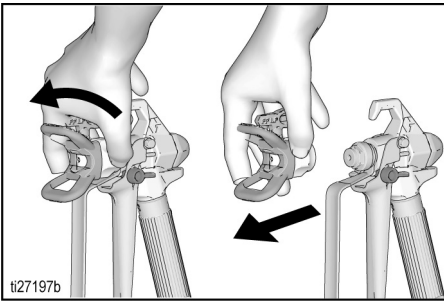

4. Remove drain tube from paint hopper, wipe excess paint off outside.

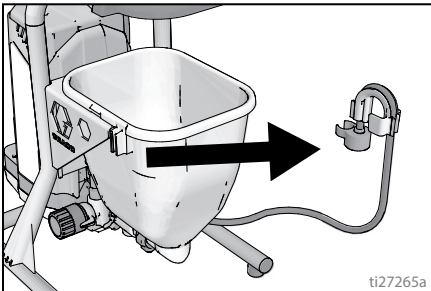

5. Place drain tube in waste pail.

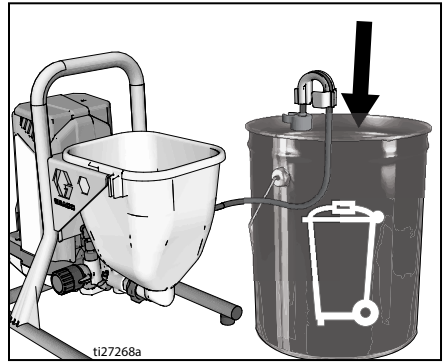

6. Pour flushing fluid into the hopper. Use water for water-based paint and mineral spirits for oil-based paint.
7. Turn Pressure Control knob to the Prime/Clean setting (lowest setting that the pump will run).

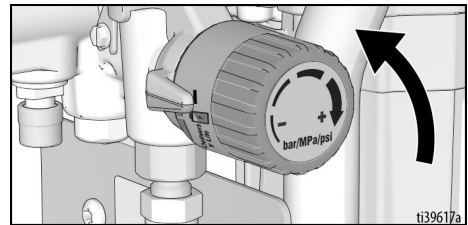

8. Press ON/OFF switch to power **ON**. Button is illuminated when ON.
9. Flush until approximately 1/3 of the flushing fluid is emptied from the hopper.
10. Press ON/OFF switch to power **OFF**. Button is not illuminated when OFF.

Cleanup

NOTE: Step 11 is for returning paint in hose to paint pail. One 50 ft (15 m) hose holds approximately 1 quart (1 liter) of paint.

11. To recover paint in hose:
 - a. Point gun into paint pail.
 - b. Disengage trigger lock.
 - c. Pull and hold gun trigger.
 - d. Place Prime/Spray valve in **SPRAY** position.

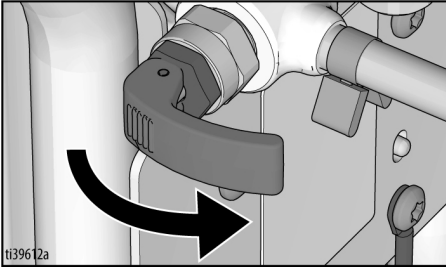

- e. Press ON/OFF switch to power **ON**. Button is illuminated when ON.
 - f. Continue to hold gun trigger until you see paint diluted with flushing fluid starting to come out of gun.

12. While continuing to trigger gun, quickly move gun to redirect spray into waste pail. Continue triggering gun into waste pail until flushing fluid dispensed from gun is relatively clear.

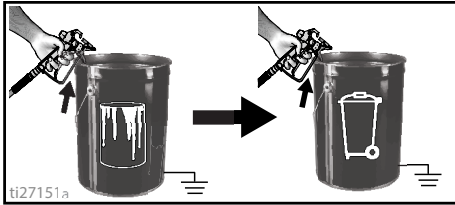

13. Stop triggering gun. Engage the trigger lock.

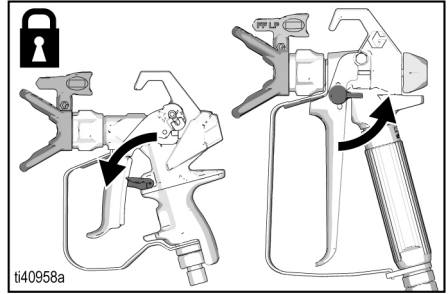

14. Place Prime/Spray valve in **PRIME** position.

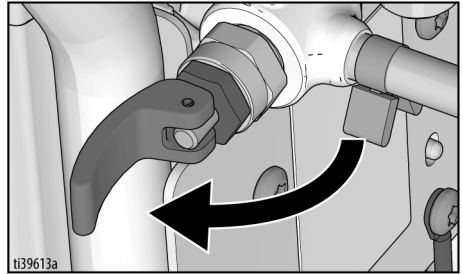

15. Press ON/OFF switch to power **OFF**. Button is not illuminated when OFF.
16. On sprayers with a filter, see **Cleaning InstaClean™ Fluid Filter**, page 31.
17. Fill unit with Pump Armor™ storage fluid. See **Storage**, page 32.
18. Remove battery, see **Battery Installation and Removal**, page 13.

Cleaning InstaClean™ Fluid Filter

(Optional)

The InstaClean Fluid Filter prevents particles from entering paint hose. After each use, remove and clean it to ensure peak performance.

1. Perform **Pressure Relief Procedure**, page 14 and remove battery, see **Battery Installation and Removal**, page 13.
2. Disconnect airless spray hose (A) from sprayer.
3. Unscrew outlet fitting (B).
4. Remove InstaClean Fluid Filter (C).

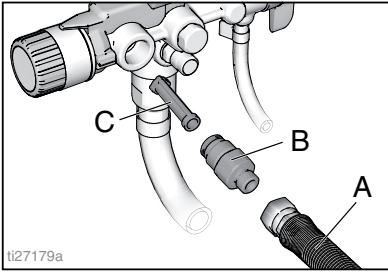

5. Check InstaClean Fluid Filter (C) for debris. If needed, clean filter with water or flushing solvent and a soft brush.
 - a. Install closed (square) end of InstaClean Fluid Filter (C) in sprayer.
 - b. Screw outlet fitting (B) into sprayer.
6. Tighten outlet fitting and reconnect hose (A) to sprayer. Use wrench to tighten securely.

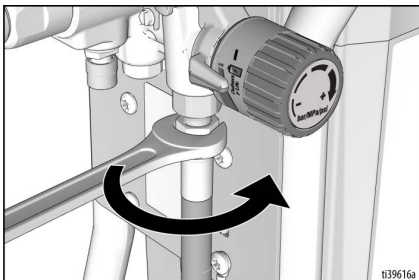

Clean the Gun

1. Perform **Pressure Relief Procedure**, page 14 and remove battery, see **Battery Installation and Removal**, page 13.
2. Clean gun fluid filter with water or flushing fluid and a brush every time you flush the system. Replace gun filter if damaged.

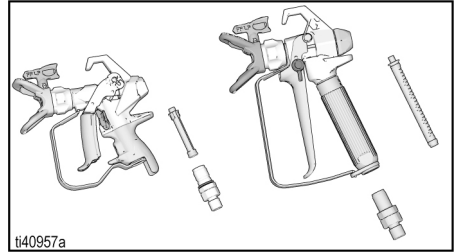

3. Remove spray tip and tip guard assembly and clean with water or flushing fluid and a brush.

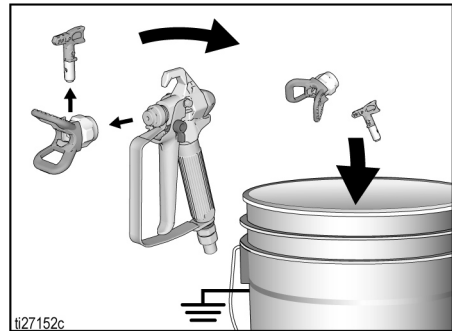

4. Wipe paint off outside of gun using a soft cloth moistened with water or flushing fluid.

Storage

Storage

With proper storage, the sprayer will be ready to use the next time it is needed.

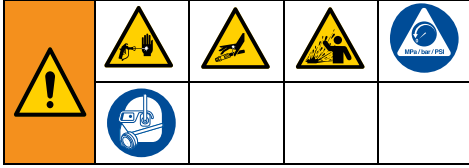

Always circulate Pump Armor storage fluid through system after cleaning. Water left in sprayer will corrode and damage pump. Follow **Cleanup**, page 25, or **Power Flush**, page 27.

- Before storing sprayer make sure all water is drained out of sprayer and hoses.
 - Do not allow water to freeze in sprayer or hose.
 - Do not store sprayer under pressure.
 - Store sprayer indoors.
1. Perform **Pressure Relief Procedure**, page 14.

- a. **For Stand Models:** Place suction tube in Pump Armor fluid bottle and drain tube in waste pail.

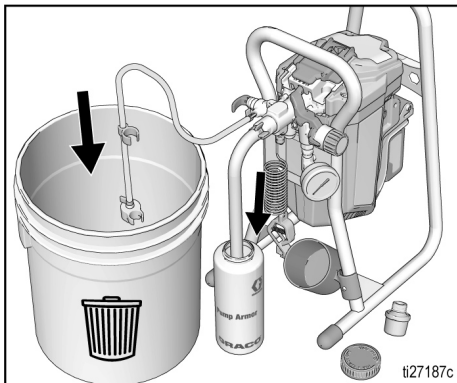

- b. **For Hopper Models:** Pour Pump Armor into the hopper and place drain tube in waste pail.



2. Place Prime/Spray valve in **PRIME** position.

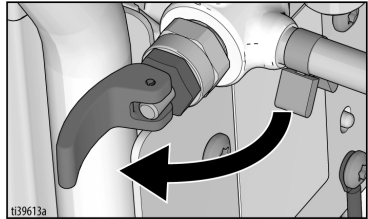

3. Press **ON/OFF** switch to **ON** position. Button is illuminated when ON.
4. Turn pressure control knob clockwise until the pump turns on.

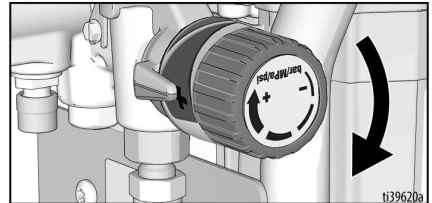

5. When storage fluid comes out of drain tube (5-10 seconds) turn **ON/OFF** switch to **OFF** position.
6. Place Prime/Spray valve in **SPRAY** position to keep storage fluid in sprayer during storage.
7. Secure a plastic bag around suction and drain tube to catch any drips.
8. Remove battery.

Reference

Spray Tip Selection

Selecting Tip Size

Spray tips come in a variety of hole sizes for spraying a range of fluids. Your sprayer includes a tip for use in most paint spraying applications. Use coatings tables on page 22 to determine the range of recommended tip hole sizes for each fluid type.

Hints:

- As you spray, the tip wears and enlarges. Starting with a tip hole size smaller than the maximum will allow you to spray within the rated flow capacity of the sprayer.
- Use larger tip hole sizes with thicker coatings and smaller tip hole sizes with thinner coatings.
- Tips wear with use and need periodic replacement.
- Tip hole size controls flow rate - the amount of paint that comes out of the gun.

Fan Width

Fan width is the size of the spray pattern, which determines the area covered with each stroke.

Hints:

- Select a fan width best suited to the surface being sprayed.
- Wider fans allow provide better coverage on broad, open surfaces.
- Narrower fans provide better control on small, confined surfaces.

Understanding Tip Number

The last three digits of tip number (i.e.: 221413) contain information about hole size and fan width on surface when gun is held 12 in. (30.5 cm) from surface being sprayed.

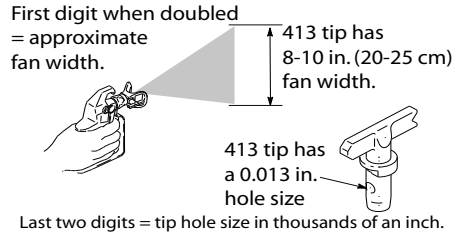

Cleaning Fluid Compatibility

- When spraying **water-based** materials, flush the system thoroughly with water.
- When spraying **oil-based or flammable** materials, flush the system thoroughly with mineral spirits or compatible flushing solvent. When flushing with solvents, always follow **Grounding Instructions**, page 10.
- To spray **water-based** materials **after spraying oil-based or flammable** materials, flush the system thoroughly with water first. The water flowing out of drain tube should be clear and solvent-free **before** you begin spraying the water-based material.
- To spray **oil-based or flammable** materials **after spraying water-based** materials, flush the system thoroughly with mineral spirits or a compatible flushing solvent first. The solvent flowing out of the drain tube should not contain any water. When flushing with solvents always follow **Grounding Instructions**, page 10.
- To avoid fluid splashing back on your skin or into your eyes, always aim gun at inside wall of pail.

Quick Reference

Page 8	Name	Description
A	ON/OFF switch	Turns sprayer ON and OFF.
B	Pressure control knob	Increases (clockwise) and decreases (counter-clockwise) fluid pressure in pump, hose, and spray gun. To select function, align symbol on pressure control knob with setting indicator, page 14.
C	Gun fluid inlet fitting	Threaded connection for airless hose.
D	Prime valve	<ul style="list-style-type: none"> In PRIME position directs fluid to drain tube. In SPRAY position directs pressurized fluid to paint hose. Automatically relieves system pressure in overpressure situations.
E	PushPrime button	Taps the inlet ball when pushed to loosen it.
F	Tip guard	Reduces risk of fluid injection injury.
G	Reversible spray tip	<ul style="list-style-type: none"> Atomizes fluid being sprayed, forms spray pattern and controls fluid flow according to hole size. Reverse position unclogs plugged tips without disassembly.
H	Airless spray	Dispenses fluid.
J	Airless hose	Transports high-pressure fluid from pump to spray gun.
K	Battery	Provides power to the sprayer (see page 3 for compatible batteries).
L	Gun trigger lock (page 9)	Prevents accidental triggering of spray gun.
M	Drain tube	Drains fluid in system during priming and pressure relief.
N	Fluid intake (suction) tube / Hopper	Draws fluid from paint pail into pump.
P	ProXChange™ Pump	Pumps and pressurizes fluid and delivers it to paint hose.
Q	Gun fluid filter	Filters fluid entering spray gun to reduce tip clogs.
R	Fluid outlet fitting	Threaded connection for airless hose.
S	Grounding wire with clamp	Provides means to maintain good ground continuity.
T	Inlet Valve Removal Tool	Cut out in the frame provide the tools to quickly remove/install the inlet valve without additional tools.
U	Outlet Ground Adapter	Provides a means to attach grounding wire clamp to grounded electrical outlet.
V	Easy Access Door	Easy Access Door permits quick access to the pump. Open pump door by pulling out on the tabs while sliding door away from the pump inlet.
W	Suction/Drain Tube Cup	Holds suction and drain hoses.
X	InstaClean™ fluid filter	<ul style="list-style-type: none"> Filters fluid coming out of pump to reduce tip plugging and improve finish. Self cleans only during pressure relief.
Y	Inlet strainer	Prevents debris from entering pump.
Z	Pump removal tool	Use cut out in the frame to remove/install pump packing.
AA	Battery shroud	Protects the battery.
	Power flush attachment	Connects garden hose to the suction tube for power flushing water-based fluids.

Maintenance

Routine maintenance is important to ensure proper operation of your sprayer.



Activity	Interval
Inspect/clean InstaClean filter, fluid inlet strainer, and gun filter.	Daily or each time you spray
Inspect motor shroud openings for blockage.	Daily or each time you spray

NOTICE

Protect the internal drive parts of this sprayer from water. Openings in shroud allow cooling of mechanical parts and electronics inside. If water gets into these openings, the sprayer could malfunction or be permanently damaged.

Airless Hoses

Check hose for damage every time you spray. Do not attempt to repair hose if hose jacket or fittings are damaged. Do not use hoses shorter than 25 ft (7.6 m). Wrench tighten, using two wrenches.

Spray Tips

- Always clean tips with compatible cleaning fluid and brush after spraying.
- Tips may require replacement after 15 gallons (57 liters) or they may last through 60 gallons (227 liters) depending on abrasiveness of paint.

Pump Repair

When pump packings wear, paint will begin to leak down outside of pump.

- Purchase a pump repair kit and install according to instructions provided with kit, before your next job.
- See **Pump Assembly**, page 46 or consult a Graco authorized retailer, distributor, or service center.

Pump Removal

Always perform **Pressure Relief Procedure**, page 14 and remove battery, see **Battery Installation and Removal**, page 13, before starting any pump repairs.

1. Pull tabs on sides of the easy access door pump towards you while pushing the entire door away from the inlet end of the pump.
2. Now lift the door so that it swivels out of the way.

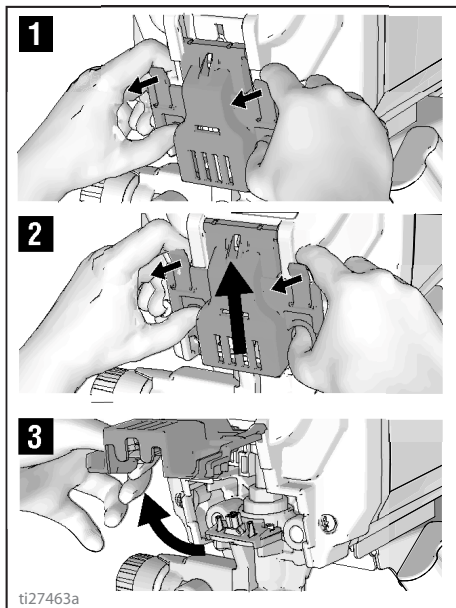

Maintenance

- Slide pump assembly off the mounting pins.

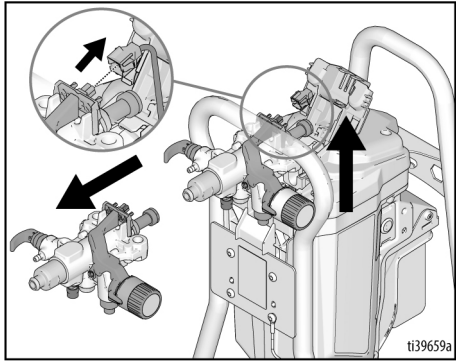

ProXChange Removal Tool

An integrated tool is included in the frame to remove the ProXChange packing assembly. See Pump repair manual for complete repair instructions.

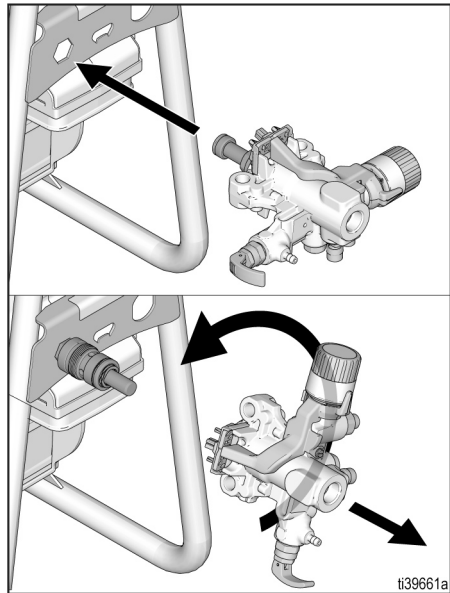

Inlet Valve Removal

An integrated tool is included in the frame to remove the inlet valve assembly from the pump. If you suspect that the inlet valve is clogged or stuck, remove the valve assembly and clean or replace.

- Remove suction tube or hopper from sprayer.
- Insert pump inlet into frame and loosen the inlet valve. Remove inlet valve.

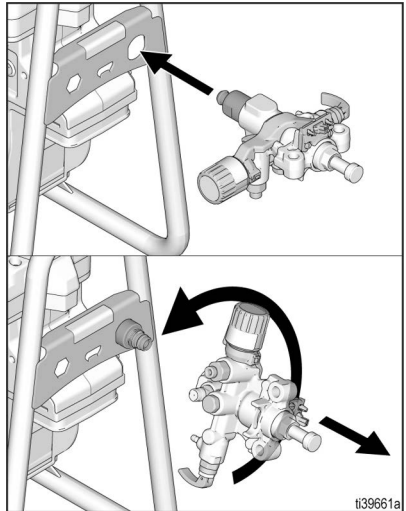

NOTICE

Do not lose the ball and spring inside the inlet valve assembly. It may fall out when the inlet valve is removed. Pump will not prime without the ball and spring.

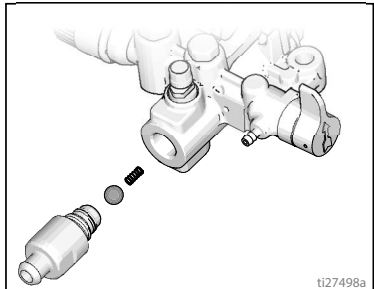

3. Clean any debris and dried paint from the cavity and replace the ball and spring. Tighten inlet valve to pump using integrated tool on the frame.

Pump Installation

1. Slide pump assembly onto the mounting pins.

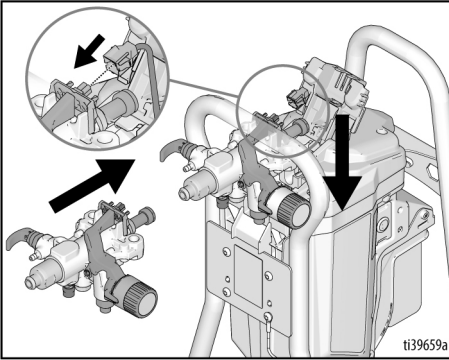

2. Move pump displacement rod up or down until cap is level with the opening in the yoke.

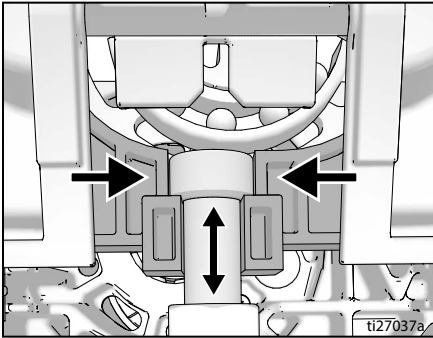

3. Swing easy access door pump door closed while pushing the entire door towards the inlet end of the pump.

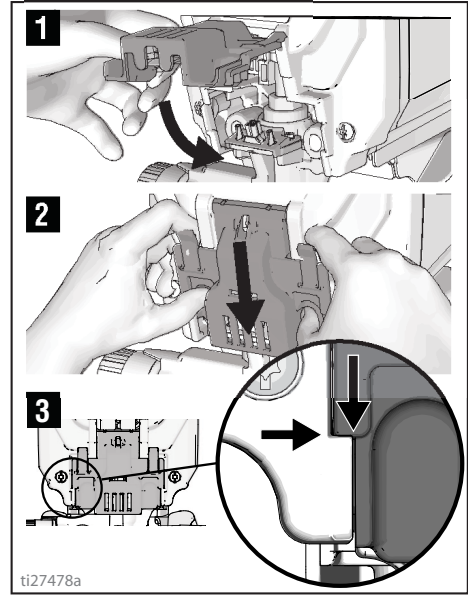

NOTE: Door must be fully closed and latched before sprayer will operate.

Troubleshooting

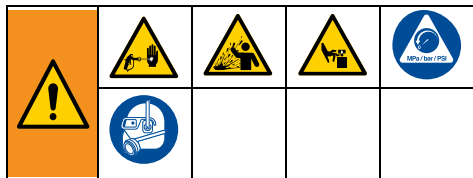

1. Follow **Pressure Relief Procedure**, page 14, before checking or repairing.
2. Solutions at the beginning of each problem listed are the most common. Start at the beginning and continue down the list to find a solution.
3. Check everything in this Troubleshooting Table before you bring the sprayer to an authorized service center.

Problem	Cause	Solution
Motor does not run: (verify battery is installed correctly and fully charged, and power switch is on)	Easy access door not fully closed.	Verify that easy access door is closed and latched. See page 37.
	Pressure control knob is set at zero pressure.	Turn pressure control knob clockwise to increase pressure setting.
	Pump is seized (Paint has hardened in pump or Water is frozen in pump.)	Turn ON/OFF switch off and remove battery. If frozen do NOT try to start sprayer until it is completely thawed or it may damage the motor, control board and/or drive train. Place sprayer in warm area for several hours. If not frozen, check for hardened paint in pump. If paint has hardened in pump. See Pump Removal , page 35. If motor does not turn with pump repaired, consult a Graco authorized retailer, distributor, or service center.
	Motor or control is damaged.	Consult a Graco authorized retailer, distributor, or service center.
	Battery has insufficient charge.	Charge battery.
Battery is defective.	Replace battery.	

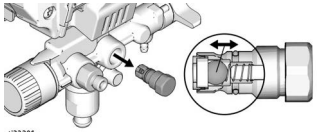
Problem	Cause	Solution	
Sprayer runs, but pump does not prime or loses prime while in use. (Pump cycles but does not pump paint or build pressure.)	Inlet valve check ball is stuck.	Press PushPrime button to dislodge the ball allowing pump to prime properly, OR Power Flush sprayer, see page 27.	
	Prime/Spray Valve is in SPRAY position.	Turn Prime/Spray Valve down to PRIME position until paint exits drain tube. The pump is now primed.	
	Pump was not primed with flushing fluid. (Thick fluids may not prime if not initially primed with flushing fluid.)	Remove suction tube from paint. Prime pump with oil or water-based flushing fluid. See page 15.	
	Debris in paint.	Strain the paint. See page 12.	
	Thick or "sticky" paint.	Some fluids may prime faster if the ON/OFF switch is momentarily turned off so the pump can slow and stop. Turn ON/OFF switch on and off several times if necessary.	
	Inlet strainer is clogged or suction tube is not immersed in paint.	Clean debris off inlet strainer and make sure suction tube is immersed in paint.	
	Inlet valve check ball or seat is dirty.	Remove inlet fitting. Clean or replace ball and seat. See page 36.	
	Suction tube is leaking.	Inspect suction tube connection for cracks or vacuum leaks.	
	Outlet valve check ball is stuck.		Unscrew outlet valve, remove, and clean assembly.
			See Pump Repair , page 35. Then reprime pump.
			Remove inlet and/or outlet valves and clean, replace and reprime. See Fill Pump , page 18.
			Make certain to not lose the ball and spring of the inlet valve assembly or the sprayer will not function. See Inlet Valve Removal , page 36.
	Make certain the outlet ball moves free in the housing before replacing.	 <p>ti33201a</p>	
	Prime/Spray Valve is worn or obstructed with debris.		Take sprayer to Graco authorized service center.







Troubleshooting

Problem	Cause	Solution
Pump is primed, but can not achieve good spray pattern.	Spray tip may be partially clogged.	Clear spray tip clog. See, Clear Tip Clog , page 24.
	Reversible spray tip is in UNCLOG position.	Rotate arrow-shaped handle on spray tip so it points forward to SPRAY position. See page 24.
	Debris in paint.	Strain the paint. See page 12.
	Pressure is set too low.	Align pressure control knob setting indicator to desired spray setting. See page 22.
	InstaClean fluid filter is clogged.	Clean or replace InstaClean fluid filter. See page 31.
	Spray gun fluid filter is clogged.	Clean or replace gun fluid filter. See page 31.
	Spray tip selected is too large for capability of sprayer.	Replace tip. See page Spray Tip Installation , page 20.
	Spray tip is worn beyond the capability of sprayer.	Replace tip. See Spray Tip Installation , page 20.
	Spray tip gasket and seal worn or missing.	Replace gasket and seal. See page 20.
	Inlet strainer is clogged or suction tube is not immersed in paint.	Clean debris off inlet strainer and make sure suction tube is immersed in paint.
	Battery has insufficient charge for tip support.	Charge battery or reduce tip size.
	Inlet pump valve or outlet pump valve is worn or clogged with debris.	Check for worn or contaminated inlet valve or outlet valve. <ul style="list-style-type: none"> - Prime sprayer with paint - Trigger gun momentarily - When trigger is released, pump should cycle momentarily and stop - If pump continues to cycle, pump valves may be worn or contaminated with debris - Clean or replace valves with appropriate kits. See page 46.
	Material is too thick.	Thin material. Follow manufacturer's recommendations.
Airless hose is too long (if extra section was added).	Remove section of airless hose.	
Spray gun stopped spraying while trigger is pulled.	Spray tip is clogged.	Clear spray tip clog. See, Clear Tip Clog , page 24.
	Sprayer lost prime.	See troubleshooting section "Sprayer runs, but pump does not prime or loses prime while in use." on page 39.
When paint is sprayed, it runs down the wall or sags.	Material is going on too thick.	Move gun faster.
		Choose a spray tip with smaller hole size.
		Choose spray tip with wider fan.
		Make sure gun is far enough from surface.

Problem	Cause	Solution
When paint is sprayed, coverage is inadequate.	Material is going on too thin.	Move gun slower.
		Choose spray tip with larger hole size.
		Choose spray tip with narrower fan.
		Make sure gun is close enough to surface.
Fan pattern varies dramatically while spraying.	Pressure control switch is worn and causing excessive pressure variation.	Take sprayer to Graco authorized service center.
Cannot trigger spray gun.	Spray gun trigger lock is engaged.	Rotate trigger lock to disengage trigger lock. See page 9.
Paint is coming out of pressure control.	Pressure control is worn.	Take sprayer to Graco authorized service center.
Paint is leaking through drain tube.	Sprayer is over pressurizing.	Take sprayer to Graco authorized service center.
Paint leaks down outside of pump.	Pump packings are worn.	Replace pump packings with new ProXChange module. See page 35.
Motor is hot and runs intermittently. Motor automatically shuts off due to excessive heat. Damage can occur if cause is not corrected.	Vent holes in enclosure are plugged or sprayer is covered.	Keep vent holes clear of obstructions and overspray and keep sprayer open to air.
	Battery has insufficient charge.	Charge battery.
	Motor needs to be replaced.	Take sprayer to Graco authorized retailer, distributor, or service center.
Sprayer makes no sound when pressure control is ON and ON/OFF switch is ON (illuminated).	ON/OFF switch light blinks two times when pressure control is ON. Indicates incorrect voltage.	Replace battery with charged battery.
		Battery has reached end of life. Replace battery.
		Motor damaged, replace motor assembly.
	ON/OFF switch light blinks three times when pressure control is ON. Indicates battery temperature is too hot or too cold.	Allow battery to cool down or warm up to room temperature.
	ON/OFF switch light blinks four times when pressure control is ON. Indicates locked rotor condition.	Replace pump and/or motor assembly.
	ON/OFF switch light blinks five times when pressure control is ON. Indicates motor temperature is too hot.	Allow motor to cool down to room temperature.
ON/OFF switch does not illuminate when pressed.	Indicates battery is not installed, has insufficient charge, or is damaged.	Install battery correctly, ensure battery is fully charged, or replace battery.
	Control board is damaged.	Replace control board.
	Power switch is damaged.	Replace power switch.
ON/OFF switch is constantly illuminated (does not turn off).	Control board is damaged.	Replace control board.

GX21 Cordless Airless Sprayer Parts

GX21 Cordless Airless Sprayer Parts

Ref.	Torque	Ref.	Torque	Ref.	Torque
	110-120 in-lb (12 - 14 N•m)		35-45 in-lb (4.0 - 5.0 N•m)		180-220 in-lb (20.3-24.9 N•m)
	30-35 in-lb (3.5 - 4.0 N•m)		23-27 in-lb (2.6 - 3.0 N•m)		
	8-10 in-lb (0.9 - 1.2 N•m)		80-90 in-lb (9.0 - 10.2 N•m)		

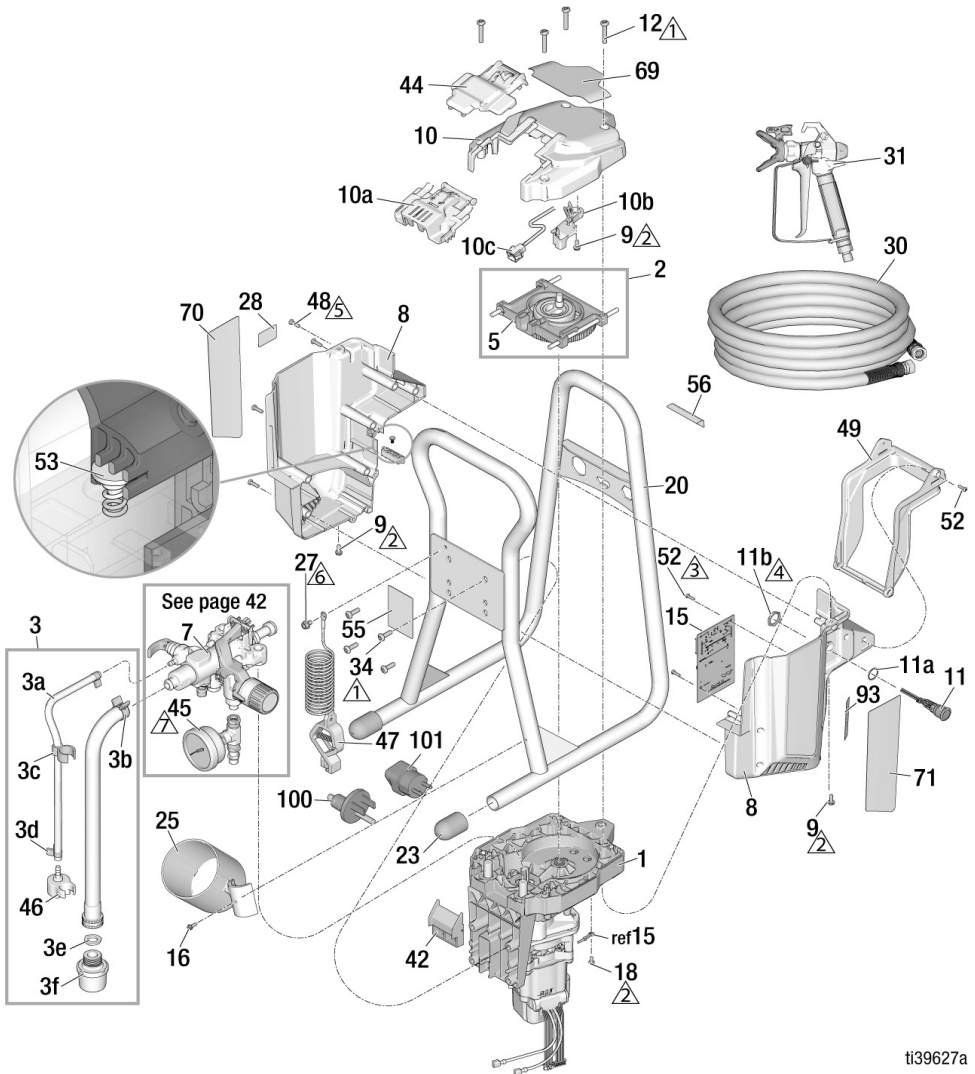

ti39627a

GX21 Cordless Airless Sprayer Parts

GX21 Cordless Airless Sprayer Parts List

Ref. Part	Description	Qty.	Ref. Part	Description	Qty.
1*	20A066 KIT, motor, <i>includes 34</i>	1	41	17J444 STRAP, carry (not shown)	1
2	17J869 KIT, gear and yoke, <i>includes 5</i>	1	42	17J277 TRAY, drip	1
3	17D161 TUBE, suction, assembly <i>includes 3a-3f, 46</i>	1	44	17J618 SHIELD, paint	1
3a	195108 TUBE, drain	1	45	245856 KIT, gauge, pressure	1
3b	116295 CLAMP, tube	1	46	244035 DEFLECTOR, barbed	1
3c	195400 CLIP, tube	1	47	237686 WIRE, ground, assembly	1
3d	115489 CLAMP, drain tube	2	48	115477 SCREW, mach, torx, pan hd.	8
3e	115099 WASHER, hose	1	49	20A387 SHIELD, battery	1
3f	288716 STRAINER	1	52	119236 SCREW, mach	5
5	17J864 KIT, yoke	1	53	20A052 SPRING, pin, assembly	1
7	17J908 PUMP, displacement	1	55	LABEL, identification	1
8	20A566 KIT, shield, motor, <i>includes 9, 28, 48, 70, 71, 93</i>	1	56▲	20A480 LABEL, warning	1
9	118444 SCREW, mach, hwhd 10-24 x 0.5 in.	2	57▲	CARD, medical alert (not shown)	1
10	17J866 KIT, cover, frt, <i>includes 9, 10a, 10b, 10c, 12</i>	1		222385 EN, ES, FR	1
10a	17F233 COVER, pump, locking	1	58	20A163 BATTERY, DEWALT, 54V, EMEA, (not shown)	1
10b	17F262 COVER, wire	1	59	20A166 CHARGER, fast, DEWALT, 54V, EMEA (not shown)	1
10c	128551 CABLE, PC, jumper	1	69	20A529 LABEL, front	1
11	19D610 SWITCH, ON/OFF	1	70	20A530 LABEL, left	1
11a	O-RING, power switch	1	71	20A531 LABEL, right	1
11b	NUT, power switch	1	75	115648 VALVE, shut off, Powerflush (not shown)	1
12	115478 SCREW, mach, Torx, pan hd	4	76	246187 FITTING, garden hose, Europe (not shown)	1
15	20A542 KIT, control, <i>includes 18, 52</i>	1	93	17P925 LABEL, A+	1
16	117501 SCREW, drill, HWH	1	100	25U295 ADAPTER, ground, outlet	1
18	115498 SCREW, mach, slot, hex whd	1	101	16H592 ADAPTER, plug, grounded, CEE/7	1
20	25U282 FRAME, direct immersion	1	110	16H593 ADAPTER, plug, grounded, UK, model 25T973 (not shown)	1
23	15G857 CAP, leg	2	111	124507 ADAPTER, UK power, model 25T973 (not shown)	1
25	15G838 CUP, suction/drain	1			
27	112798 SCREW, thread	1			
28	16D576 LABEL, made in USA	1			
30	247340 HOSE, cpld, 1/4 in. x 50 ft	1			
31	17J910 GUN, spray				
34	128795 SCREW, hwh, thread forming	4			

▲ Replacement safety labels, tags, and cards are available at no cost.

GX19 and GX FF Portable Hopper Sprayer

GX19 and GX FF Portable Hopper Sprayer Parts

Ref.	Torque	Ref.	Torque	Ref.	Torque
	110-120 in-lb (12-14 N•m)		35-45 in-lb (4-5 N•m)		
	30-35 in-lb (2.4-4 N•m)		23-27 in-lb (2.6-3 N•m)		
	8-10 in-lb (0.9-1.1 N•m)		80-90 in-lb (9-10.2 N•m)		

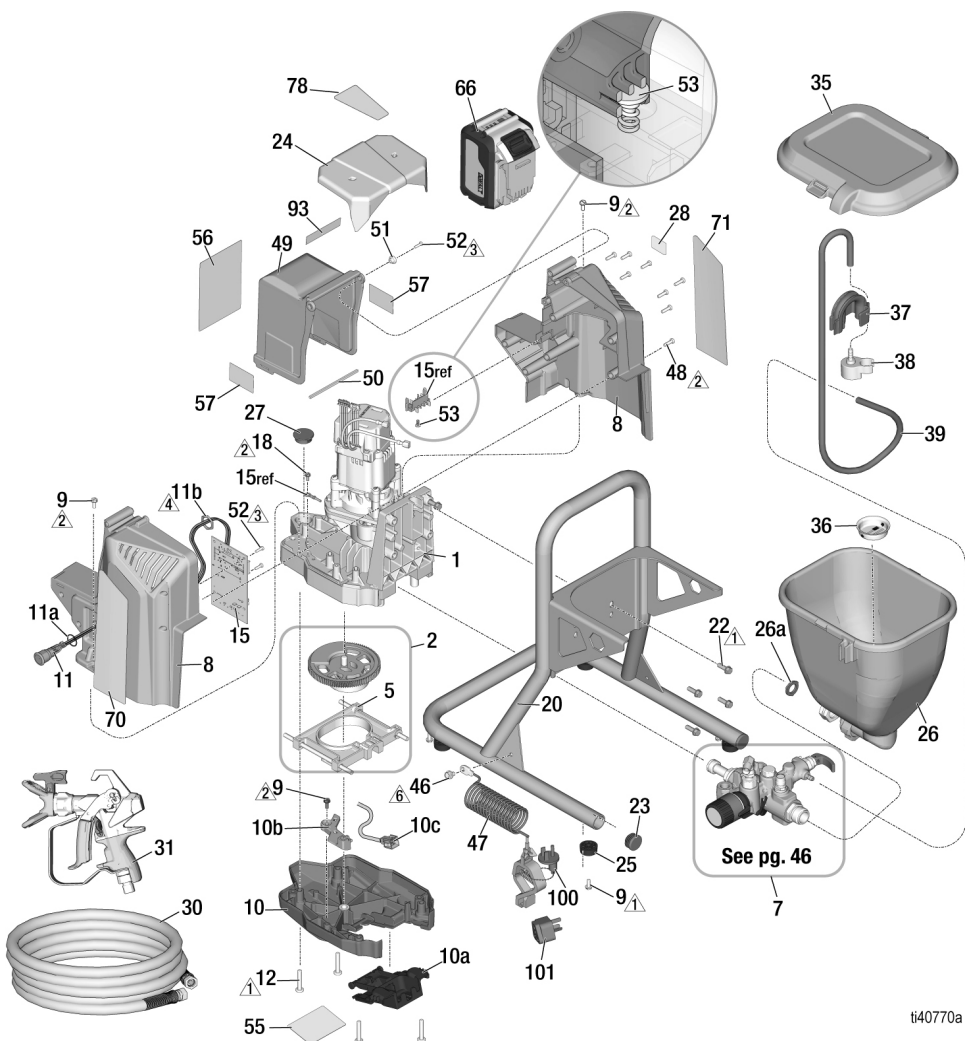

i40770a

GX19 and GX FF Portable Hopper Sprayer







GX19 and GX FF Portable Hopper Sprayer Parts List

Ref.	Part	Description	Qty.	Ref.	Part	Description	Qty.
1	20A066	KIT, motor, drive	1	51	20A010	BUTTON, door hinge	1
2	17J863	KIT, gear and yoke, <i>includes</i> 5	1	52	119236	SCREW, mach, torx, pan hd.	3
5	175864	KIT, yoke	1	55		LABEL, identification	1
7	17J909	KIT, pump, hopper	1	56 ▲		LABEL, safety, warning	1
8		KIT, shroud, motor, <i>includes</i> 9, 48, and labels	1	20A795	Model 25U341		
	20A944	NA/ANZ models 25U341, 25U855		20A480	Models 25U466, 25U570		
	20A945	EMEA/UK models 25U466, 25U570		20B081	Model 25U855		
9	118444	SCREW, hex head	7	59		CHARGER, fast, DEWALT (not shown)	1
10	17J866	KIT, cover, front, <i>includes</i> 9, 10a, 10b, 10c, 12	1	20A165	60V, USA/CA, model 25U341		
10a	17F233	COVER, pump, locking	1	20A166	54V, EMEA/UK, models 25U466, 25U570		
10b	17F262	COVER, wire	1	20A167	54V, ANZ, model 25U855		
10c	128551	CABLE, PC, jumper	1	66		BATTERY, DEWALT	1
11	19D610	SWITCH, ON/OFF, power	1	20A162	60V, USA/CA, model 25U341		
11a		O-RING, power switch	1	20A163	54V, EMEA/UK, models 25U466, 25U570		
11b		NUT, power switch	1	20A164	54V, ANZ, model 25U855		
12	115478	SCREW, mach, torx, pan head	1	70		LABEL, right, GX19	1
15	20A542	KIT, control board, <i>includes</i> 18, 52	1	20A857	Models 25U341, 25U855		
18	115498	SCREW, mach, slot hex hd.	1	20A861	Models 25U466, 25U570		
20	17H426	FRAME, assembly	1	71		LABEL, left, GX19	1
22	260212	SCREW, hex head	4	20A856	Models 25U341, 25U855		
23	120151	REATINER, cap plug	2	20A860	Models 25U466, 25U570		
24	17H593	COVER, vent shroud	1	78	20A858	LABEL, top, GX19, cordless	1
25	17K640	DAMPER, feet	4	93		A+ service label	1
26	17J244	KIT, hopper, 1.5 gallon, <i>includes</i> 26a, 35	2	17P924	Model 25U341		
26a	115099	WASHER, hose	1	17P925	Models 25U570, 25U466, 25Y855		
27	175819	PLUG	1	100	25U295	ADAPTER, ground, outlet	1
28	16D576	LABEL, made in USA	1	101	16H592	ADAPTER, plug, grounded, models 25U466, 25U570	1
30	214698	HOSE, 3/16 in. x 25 ft.	1	16H835	ADAPTER, plug, grounded, AS3112/ANZ, model 25U855		
31	19Y443	GUN, contractor PC, compact	1	110	16H593	ADAPTER, plug, grounded, UK, model 25U570 (not shown)	1
35	17H417	LID, hopper	1	111	124507	ADAPTER, UK power, model 25U570 (not shown)	1
36	112133	SCREEN, hopper	1	▲	222385	CARD, medical alert (not shown), NA/EMEA	1
37	17H419	CLIP, drain hose	1	▲	17A134	CARD, medical alert (not shown), ANZ	1
38	244035	DEFLECTOR, barbed	1				
39	17K336	TUBE, drain, <i>includes</i> 37, 38	1				
46	112798	SCREW, thread, hex hd.	1				
47	237686	WIRE, ground assembly with clamp	1				
48	115477	SCREW, mach, torx, pan hd.	8				
49	20A544	KIT, door, battery, <i>includes</i> 51, 52	1				

▲ Replacement safety labels, tags, and cards are available at no cost.

Pump Assembly

Pump Assembly

Ref.	Torque	Ref.	Torque
 1	140-160 in-lb (16 - 18 N•m)	 4	220-250 in-lb (25 - 28 N•m)
 2	270-330 in-lb (30 - 37 N•m)	 5	320-380 in-lb (36 - 43 N•m)
 3	30-35 ft-lb (40 - 48 N•m)	 6	180-220 in-lb (20 - 25 N•m)

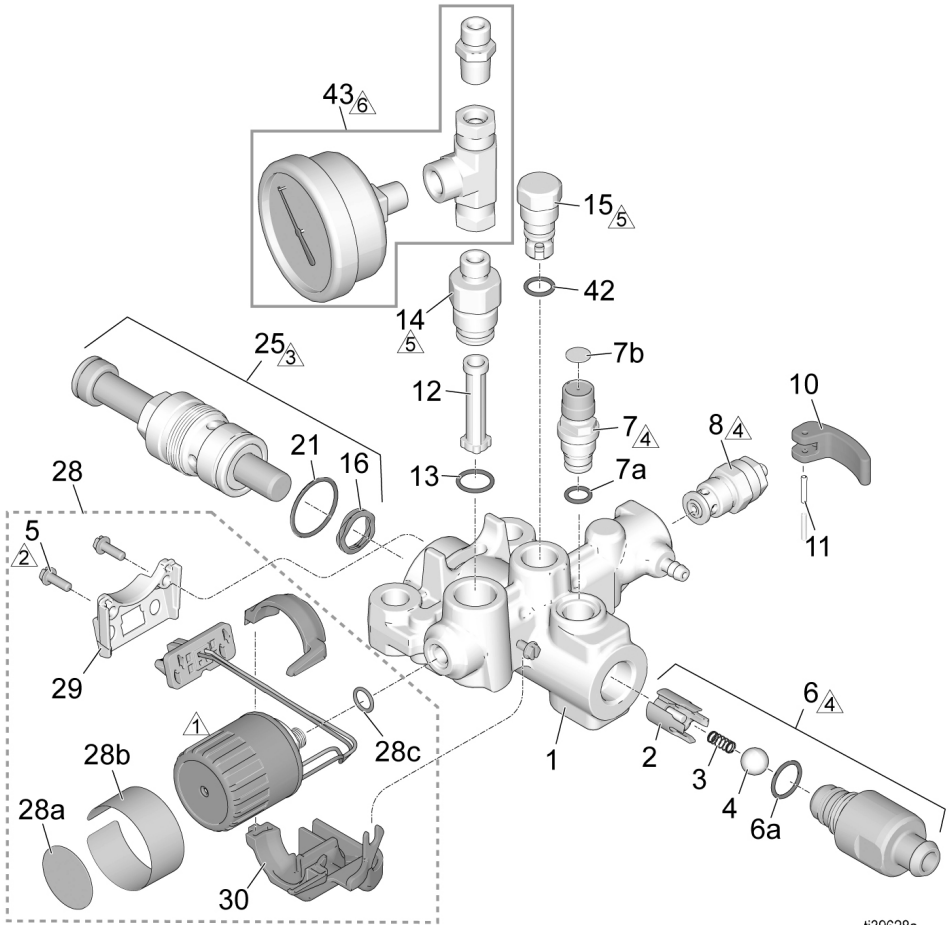

ti39628a

Pump Assembly Parts List

Ref. Part	Description	Qty.	Ref. Part	Description	Qty.
1	HOUSING, pump	1	14	24Y327	KIT, repair outlet, <i>includes</i>
	17G447			12, 13	
	17H605		15	17J880	KIT, outlet valve repair
2	17D364	1		<i>includes</i> 42	1
3	128336	1	16	128323	SPRING, valve
4	105445	1	21	16D531	PACKING, O-ring
5	117501	2	25	24Y472	KIT, repair, piston pump,
6		1		<i>includes</i> 16, 21	1
	17J876		28	20A567	KIT, pressure control,
	17J924			<i>includes</i> 5, 28a, 28b, 28c,	
6a	124582	1		29, 30	
7	17J878	1	28a	20A474	LABEL, control
			28b	20A475	LABEL, control
7a	16P303	1	28c	106555	O-ring
7b	17K420	1	29	17F227	BRACKET, electrical
8	17J925	1		connector	1
			30	17J882	KIT, shield, wire
10	15Y185	1	42	122486	PACKING, O-ring
11	111600	1	43		MODULE, assembly,
12	288747	1		pressure gauge	1
				17K219	GX21 stand models
13	120776	1		16X147	GX19 hopper models

Wiring Diagrams

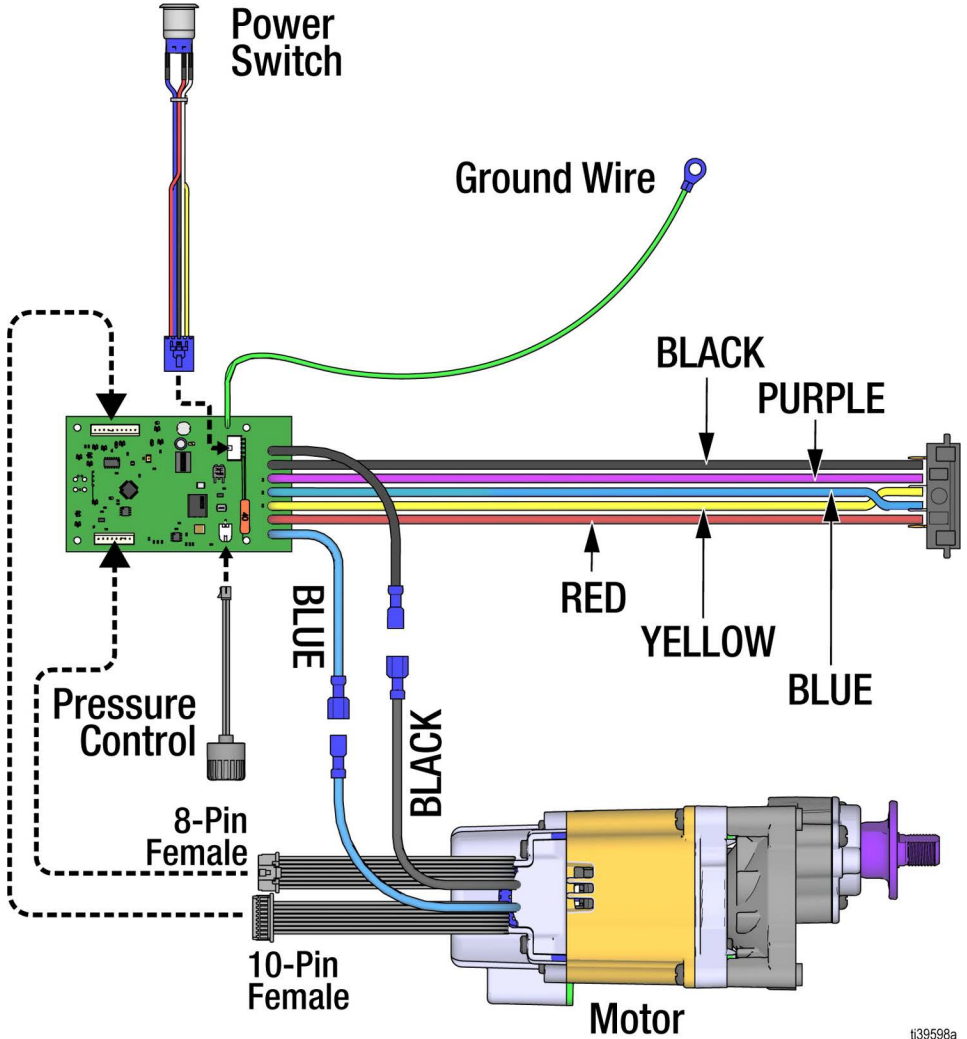

ti39598a

Technical Specifications

GX21, GX19 and GX FF Cordless Sprayers				
	US		Metric	
Sprayer	GX21	GX19 and GX FF	GX21	GX19 and GX FF
Maximum fluid working pressure	3000 psi		207 bar, 20.7 MPa	
Maximum Delivery	0.47 gpm	0.38 gpm	1.8 lpm	1.4 lpm
Maximum Tip Size	0.021 in.	0.019 in.	0.053 mm	0.048 mm
Fluid Outlet npsm	1/4 in.		1/4 in.	
Power Requirements	See Models , page 3, for power requirements.			
Dimensions				
Height	22 in.	19.6 in.	55.9 cm	49.8 cm
Length	18.4 in.	20.2 in.	46.7 cm	51.3 cm
Width	12 in.	13.5 in.	30.5 cm	34.3 cm
Weight (with battery)	28.5 lb. (31 lb.)	32.5 lb. (35 lb.)	12.9 kg (14.1 kg)	14.7 kg (15.9 kg)
Storage temperature range ♦ ❖	-30° to 160°F		-35° to 71°C	
Operating temperature range ✓	40° to 115°F		4° to 46°C	
Noise**				
Sound pressure	83 dBa*			
Sound power	93 dBa*			
Materials of Construction				
Wetted materials on all models	stainless steel, brass, leather, ultra-high molecular weight polyethylene (UHMWPE), carbide, nylon, aluminum, PVC, polypropylene, fluoroelastomer			
Notes				
* <i>Startup pressures and displacement per cycle may vary based on suction condition, discharge head, air pressure, and fluid type.</i>				
** <i>Sound pressure measured 3 feet (1 meter) from equipment. Sound power measured per ISO-9614.</i>				
♦ When pump is stored with non-freezing fluid, pump damage will occur if water or latex paint freezes in pump.				
❖ Damage to plastic parts may result if impact occurs in low temperature conditions.				
✓ Changes in paint viscosity at very low or very high temperatures can affect sprayer performance.				

California Proposition 65

CALIFORNIA RESIDENTS

 **WARNING:** Cancer and reproductive harm –
www.P65warnings.ca.gov.

Graco Standard Warranty

Graco Standard Warranty

Graco warrants all equipment referenced in this document which is manufactured by Graco and bearing its name to be free from defects in material and workmanship on the date of sale to the original purchaser for use. With the exception of any special, extended, or limited warranty published by Graco, Graco will, for a period of twelve months from the date of sale, repair or replace any part of the equipment determined by Graco to be defective. This warranty applies only when the equipment is installed, operated and maintained in accordance with Graco's written recommendations.

This warranty does not cover, and Graco shall not be liable for general wear and tear, or any malfunction, damage or wear caused by faulty installation, misapplication, abrasion, corrosion, inadequate or improper maintenance, negligence, accident, tampering, or substitution of non-Graco component parts. Nor shall Graco be liable for malfunction, damage or wear caused by the incompatibility of Graco equipment with structures, accessories, equipment or materials not supplied by Graco, or the improper design, manufacture, installation, operation or maintenance of structures, accessories, equipment or materials not supplied by Graco.

This warranty is conditioned upon the prepaid return of the equipment claimed to be defective to an authorized Graco distributor for verification of the claimed defect. If the claimed defect is verified, Graco will repair or replace free of charge any defective parts. The equipment will be returned to the original purchaser transportation prepaid. If inspection of the equipment does not disclose any defect in material or workmanship, repairs will be made at a reasonable charge, which charges may include the costs of parts, labor, and transportation.

THIS WARRANTY IS EXCLUSIVE, AND IS IN LIEU OF ANY OTHER WARRANTIES, EXPRESS OR IMPLIED, INCLUDING BUT NOT LIMITED TO WARRANTY OF MERCHANTABILITY OR WARRANTY OF FITNESS FOR A PARTICULAR PURPOSE.

Graco's sole obligation and buyer's sole remedy for any breach of warranty shall be as set forth above. The buyer agrees that no other remedy (including, but not limited to, incidental or consequential damages for lost profits, lost sales, injury to person or property, or any other incidental or consequential loss) shall be available. Any action for breach of warranty must be brought within two (2) years of the date of sale.

GRACO MAKES NO WARRANTY, AND DISCLAIMS ALL IMPLIED WARRANTIES OF MERCHANTABILITY AND FITNESS FOR A PARTICULAR PURPOSE, IN CONNECTION WITH ACCESSORIES, EQUIPMENT, MATERIALS OR COMPONENTS SOLD BUT NOT MANUFACTURED BY GRACO. These items sold, but not manufactured by Graco (such as electric motors, switches, hose, etc.), are subject to the warranty, if any, of their manufacturer. Graco will provide purchaser with reasonable assistance in making any claim for breach of these warranties.

In no event will Graco be liable for indirect, incidental, special or consequential damages resulting from Graco supplying equipment hereunder, or the furnishing, performance, or use of any products or other goods sold hereto, whether due to a breach of contract, breach of warranty, the negligence of Graco, or otherwise.

FOR GRACO CANADA CUSTOMERS

The Parties acknowledge that they have required that the present document, as well as all documents, notices and legal proceedings entered into, given or instituted pursuant hereto or relating directly or indirectly hereto, be drawn up in English. Les parties reconnaissent avoir convenu que la rédaction du présente document sera en Anglais, ainsi que tous documents, avis et procédures judiciaires exécutés, donnés ou intentés, à la suite de ou en rapport, directement ou indirectement, avec les procédures concernées.

Graco Information

For the latest information about Graco products, visit www.graco.com.

For patent information, see www.graco.com/patents.

TO PLACE AN ORDER, contact your Graco distributor or call 1-800-690-2894 to identify the nearest distributor.

All written and visual data contained in this document reflects the latest product information available at the time of publication.

Graco reserves the right to make changes at any time without notice.

Original instructions. This manual contains English. MM 3A8429

Graco Headquarters: Minneapolis

International Offices: Belgium, China, Japan, Korea

GRACO INC. AND SUBSIDIARIES • P.O. BOX 1441 • MINNEAPOLIS MN 55440-1441 • USA

Copyright 2021, Graco Inc. All Graco manufacturing locations are registered to ISO 9001.

www.graco.com

Revision B, December 2021