

WAGNER PRESENTS

Contractor 2023

PRODUCT NAVIGATION



BE UNSTOPPABLE!

WAGNER



INNOVATION SINCE 1947

Perfect surfaces and added value are our passion. Bringing colour, protection and function to surfaces is our mission. We dedicate all of our technical expertise to enhance our products, and support you with a personal level of service. Using innovative Technologies and highly efficient, reliable and user-friendly solutions, we are constantly setting new standards in surface technology.

Facades, walls, furniture, doors, steel structures, mobile phones, car wheel rims and controls, leather sofas and radiators – there are hardly any objects which cannot be surface finished. Clearly along with function, durability and attractiveness, the surface of an object is its definition. Your customers, as professionals all want to achieve a high level quality finish. WAGNER can help support your business with high quality professional equipment which is both time saving and cost effective.

Different application areas characterise the product range of the contractor sector:

SMALL PROJECTS: Spraying units for repair and touch-up work. Ideal for all projects in the renovation and new construction sector when using the unit irregular and rare. Good price-performance ratio.

BUILDING TRADE: Units for Painters and Plasterers. Ideal for all interior and exterior applications, for a wide range of surfaces, walls, ceiling radiators and door frames. Powerful screw pumps for heavy aggregated material.

WOOD AND METAL WORK: Spray units for painting a wide range of objects such as stairs, floors, kitchens, furniture and railings with water diluted or solvent based paints.

CORROSION AND STRUCTURAL PROTECTION: Applying protective coatings with airless technology and electric or petrol-driven piston pumps.

PREPARING: Power tools for the removal of paint and wallpaper.

The range for each stretches from small entry level units through all rounder units right up to specialised plant. Comprehensive accessories guarantee an optimal match to the object in question.

WAGNER develops numerous product innovations in close contact with users, paint manufacturers and scientific institutions. Our 1500 square metre technology centre in Markdorf plays an important role in practical research and relaying knowledge. For example interregional master classes to consoli-date the training for the painting trade have taken place here for years. We provide a comprehensive Service Network and also a large number of specialist advisers to help you in an instant.

WAGNER GROUP WORLDWIDE

- Around 2,000 employees
- 19 operational companies, including 5 production plants
- Around 400 international agencies
- A 1,500 m² Technology Centre in Markdorf and a further 7 throughout the world
- Worldwide service directly on site



PUMP OVERVIEW ACCORDING TO MATERIALS

| MATERIALS | Water and solvent-based paints, lacquers, oils, separating agents | Synthetic resin varnishes, PVC lacquers, 2K lacquers | Primers, fillers | Fire protection, rust protection paints | Emulsion and latex paints, adhesives, sealants | Exterior paints, roof coatings, floor coatings, textured paint | Structural waterproofing, bituminous coatings | Filler | Plaster | Injection |
|------------------------------------|---|--|------------------|---|--|--|---|--------|---------|-----------|
| FinishControl 3500 | | | | | | | | | | |
| FinishControl 5500 | | | | | | | | | | |
| FineCoat 9700 | | | | | | | | | | |
| FineCoat 9900 Plus | | | | | | | | | | |
| SuperFinish 23 Pro HEA | | | | | | | | | | |
| SuperFinish 23 Plus HEA | | | | | | | | | | |
| SuperFinish 23 Plus Airless Enamel | | | | | | | | | | |
| SuperFinish 23 Plus TempSpray | | | | | | | | | | |
| SuperFinish 23 Plus AirCoat Enamel | | | | | | | | | | |
| SuperFinish 23 CR | | | | | | | | | | |
| SuperFinish 33 Pro | | | | | | | | | | |
| SuperFinish 33 Plus | | | | | | | | | | |
| PowerPainter 90 Extra | | | | | | | | | | |
| ProSpray 3.20 HEA | | | | | | | | | | |
| ProSpray 3.21 HEA | | | | | | | | | | |
| ProSpray 3.25 | | | | | | | | | | |
| ProSpray 3.31 | | | | | | | | | | |
| ProSpray 3.39 Emulsion | | | | | | | | | | |
| ProSpray 3.39 Filler | | | | | | | | | | |
| HeavyCoat 750 E/G & E SSP | | | | | | | | | | |
| HeavyCoat 950 E/G & E SSP | | | | | | | | | | |
| HeavyCoat 970 E/G & E/G SSP | | | | | | | | | | |
| PlastCoat HP 30 | | | | | | | | | | |
| PlastCoat 1030 E | | | | | | | | | | |



Small projects
up to 50 m²



Residential
50 m² - 200m²



Suitable material



Large residential
200 m² - 800m²



Commercial
more than 800m²



Suitable material -
additional accessories
are needed

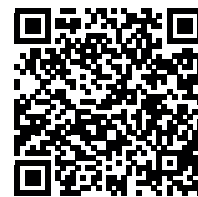

To our SprayGuides:
go.wagner-group.com/sprayguide

MACHINE & MATERIAL PERFECTLY MATCHED

The extensive WAGNER SprayGuide offers you test reports from well-known material manufacturers for use with WAGNER spray machines.

Visit go.wagner-group.com/sprayguide to find out how to set up your machine to match the material you are using, and which paints and lacquers can be sprayed most effectively with WAGNER technology.

- ➔ Search by material type
- ➔ Search by material manufacturer
- ➔ Search by WAGNER machine and systems

WAGNER
 GUARANTEE

3+2
 EXTRA YEARS

Anyone purchasing a WAGNER paint sprayer automatically receives a three-year manufacturer's warranty. But we can do more: If you register online, you can extend this warranty for a further two years, free of charge!

go.wagner-group.com/3plus2



FURTHER TRAINING IN OUR MODERN TRAINING CENTRE

Equipment technology represents the future of professional painting and decorating within the context of normal, efficient, high-quality site work. This is why it is particularly important to us to not only provide you with the technology but also to convey the corresponding know-how. After all, even the very best products only create the best surface when used in combination with specialist professional knowledge.

Whether user, plant manager, material manufacturer or sales partner - the new WAGNER ACADEMY offers every target group high-quality training modules for professional and personal further education.

THE TRAINING CENTRE IN MARKDORF ON LAKE CONSTANCE HAS AT ITS DISPOSAL:

- Three seminar rooms with state-of-the-art presentation and conference technology
- Practical zone with different, mobile demo areas
- Technical centre for service issues
- Painting booth with extraction system

| | BASIC CERTIFICATION | ADVANCED CERTIFICATION | EXPERT CERTIFICATION |
|---|--|--|---|
| WAGNER training courses to choose from | <ul style="list-style-type: none"> • Mechanical paint application from paint to plaster | <ul style="list-style-type: none"> • Paint materials • Interior wall paint • Exterior & building protection material • Fillers & plaster | <ul style="list-style-type: none"> • HVLP & XVLP technology • SuperFinish technology • ProSpray technology • HeavyCoat technology |
| Duration | 1 day (50 % Theory, 25 % Demo, 25 % Training) | 1 day (50 % Theory, 25 % Demo, 25 % Training) | 1 day (45 % Theory, 10 % Demo, 45 % Training) |
| Prior knowledge | none | WAGNER Basic Operator Training (recommendation) | WAGNER Advanced Operator Training (recommendation) |



You can find training dates online at go.wagner-group.com/academy-contractor
Registration and further information can also be found on our website.

We come to you!
All training courses can also be held conveniently at your premises. Please contact us at:
Academy.DF@wagner-group.com or call +49 (0) 7544 505 1602

HVLP/XVLP TURBINES

High air volume – low air pressure

Are you looking for a versatile spray device that offers a wide range of applications for improvement and renovation work on small to medium-sized construction sites? Then the modular low-pressure spray systems with HVLP- and XVLP technology (Xtra Volume Low Pressure) from WAGNER are perfect for you – especially in terms of quality, functionality and value for money. Low-pressure spraying involves working with a large air volume and a low air pressure (up to 0.7 bar) – which results in a high working speed and minimal overspray.



Particularly powerful and flexible:

In low-pressure spraying, the atomising air generated in the turbine flows through an air hose to the paint container on the spray gun, where it then builds up pressure. This delivers the coating material through the material tube to the nozzle and atomises it with the remaining air. The spray devices of the WAGNER XVLP series offer much better atomisation performance compared to other lower-pressure devices (HVLP), thanks to a 60 percent greater air volume and 30 percent more surface coverage.

Well-equipped for daily use on construction sites:

The modular system consists of a turbine and various spray attachments which enables the application of wood stains, varnishes and lacquers through to emulsions with professional quality. Thanks to the practical Click & Paint function, the attachments can be changed with a simple movement. The XVLP devices from WAGNER are perfect when starting to use spray equipment or to add to the range of devices available on site.

1. LESS OVERSPRAY

The HVLP- and XVLP spray devices combine the positive properties of low pressure with those of a high-pressure procedure, i.e.: Less overspray and fine atomisation result in an optimised consumption of material.

2. OPTIMAL ADJUSTMENT OPTIONS

The volume of air and material can be perfectly adjusted directly on the gun and therefore quickly changed to match various objects using a rotary control.

3. INNOVATIVE NOZZLE TECHNOLOGY

The XVLP spray devices combine the properties of low pressure with those of a high-pressure procedure. The combination of a large air volume and innovative, Visco slot nozzle technology enables a high working speed with excellent surface quality even with highly viscous paint.

4. A VARIETY OF POSSIBLE USES

The devices are especially versatile thanks to three spray attachments – StandardSpray, FineSpray and WallSpray – which are ideal for handling various materials. Thanks to the practical Click & Paint function, the spray attachments can be changed with a simple movement.

APPLICATION AREA ADVANTAGES HVLP AND XVLP TECHNOLOGY

| Lacquers | Enamels | | Emulsions |
|----------|----------|----------------|-----------|
| | standard | high-viscosity | |
| HVLP | | | |
| XVLP | | | |

ADVANTAGES

- Easy to use
- Spray pattern adjustable to object
- Spraying of undiluted materials
- All settings directly on the gun
- Quick material change with Click & Paint system (XVLP)

FINISHCONTROL 3500 SPRAYPACK

All-rounder for small projects: The entry-level answer for professional coating with spray technology

- **Universally suitable:** for use with varnishes, lacquers and emulsion paints, thanks to a modular spraying attachment system for simple material changes
- **Total control:** directly on the gun
- **Handy:** the smallest in class accompanies you on all job sites with a convenient carrying strap
- **Flexible:** ideal for repair jobs and restoration projects
- **Compact and portable:** the practical transport case offers space for the machine and two additional spraying attachments, which can be transported upright and filled

The trend-setting Visco nozzle technology: produces a particularly high-quality spray pattern. This is achieved thanks to the flat jet delivered by the slot nozzle which also ensures a high working speed

Click & Paint System: the paint-carrying spray attachment can be easily removed from the gun for easy cleaning. Additional spray attachments allow you to work with different materials and change colours rapidly



Direct Spray Control: FinishControl is particularly easy to use. (1) The continuously adjustable air volume and the (2) material volume control ensure a precisely tailored approach to the material. (3) The spraying level and spray pattern width can be adjusted to suit the item being coated



High-performance turbine with a light weight: Start the turbine easily on the gun by pressing the trigger into the first level. Depress the trigger completely to start the material flow

| TECHNICAL DATA | FINISHCONTROL 3500 |
|--------------------------|--|
| Voltage | 230 V / 50 Hz |
| Motor output | 700 W |
| Operating pressure, max. | 0.2 bar, 0.02 MPa |
| Weight | 3.5 kg |
| Scope of delivery | Turbine housing with handle; Spray attachment Standard-Spray; Carrying case; Air filter (3 pcs.); Carrying strap with strap holder; Cleaning brush |
| Art. No. | 2341501 |



FINISHCONTROL 5500 SPRAYPACK

Perfect finishes made easy

- **Click&Paint system:** for fast spray attachment changes and simple cleaning
- **DirectSprayControl:** precise and easy handling due to adjustable material and air volume, as well as adjustment of the paint jet directly on the gun
- **Highly efficient turbine:** with optimum atomisation performance
- **Easy maintenance:** easily accessible double filters with warning light indicating that the air filters need to be changed
- **Fast cleaning:** spray attachment with minimal number of components

Click & Paint System: detachable gun for fast spray attachment changes and simple cleaning

Direct Spray Control: precise and easy handling due to adjustable material and air volume, as well as the spray pattern, directly on the gun

Filter warning light: indicates when the filter needs cleaning or replaced

Integrated storage box: ideal for needles, air caps, tools and cleaning accessories

Cup holder: ideal for storage and transport of 1000 ml XVLP cups



XVLP gun & cup: improved ergonomical design, haptic and atomization

Spray attachment StandardSpray: pleasant to work with due to low spray mist and compact, extra-light design. The minimal number of components ensures easy cleaning and maintenance

Twin air filters: easily accessible filters with large surface for optimal atomisation

| TECHNICAL DATA | FINISHCONTROL 5500 |
|--------------------------|---|
| Voltage | 230 V / 50 Hz |
| Motor output | 1.15 kW |
| Operating pressure, max. | 0.29 bar, 0.029 MPa |
| Weight | 6.6 kg |
| Scope of delivery | Base unit FinishControl 5500; Air hose incl. handle, 5 m; XVLP Spray attachment StandardSpray; Cleaning kit |
| Art. No. | 2422986 |



FINECOAT 9700 SPRAYPACK

The specialist for lacquer

- **HVLP Ultra gun:** ergonomic design for fatigue-free spraying
- **Exact adjustment possibilities to the object and an unmistakably fine spray pattern:** even with water dilutable materials
- **Twin air filters:** easily accessible filters with large surface for optimal atomisation
- **Integrated storage box:** ideal for needles, air caps, tools and cleaning accessories

HVLP Ultra Gun:

improved ergonomics and fine atomisation

Precise adjustment of the spray pattern: the spray jet can be perfectly adjusted to the object to be coated

Filter warning light: indicates when the filter needs cleaning or replaced

Gun holder: for HVLP guns with gravity feed cup (gun with gravity feed cup available as separate accessory)

Integrated storage box: ideal for needles, air caps, tools and cleaning accessories

Twin air filters: easily accessible filters with large surface for optimal atomisation

Cup holder: for storage and transport of the HVLP gun with cup

| TECHNICAL DATA | FINECOAT 9700 |
|--------------------------|--|
| Voltage | 230 V / 50 Hz |
| Motor output | 1.15 kW |
| Operating pressure, max. | 0.3 bar, 0.03 MPa |
| Weight | 6.8 kg |
| Scope of delivery | Base unit FineCoat 9700; HVLP air hose, 7.6 m; HVLP FineCoat Gun Ultra; Cleaning kit |
| Art. No. | 2426601 |



FINECOAT 9900 PLUS SPRAYPACK

High-performance HVLP paint specialist in a handy design

- **Compact and easy to use**
- **Permits precise adaptation to the object to be painted and provides an unmistakably fine spray pattern:** even with water-based materials
- **Wide range of applications:** both interiors and exteriors
- **Not suitable for:** use in potentially explosive atmospheres

Precise adjustment of the spray pattern: directly on the gun. This way the pattern can be set precisely to the particular object to be coated

Practical holder: for the gun. During breaks in work and when transporting, the gun can be safely stored on the unit

In a single operation: the air flow rate and the material flow rate can be regulated directly on the gun

Quick cleaning of the filter: take out the filter without tools, just briefly knock out or blow out and refit. Dirty filter warning light indicates if the filter has to be cleaned

Ergonomic gun build: the gun fits comfortably in the hand and is less tiring to use. In addition, the gun is very energy efficient

Dual air filtration: one on the cooling side and another one on the atomizing side with an automotive type air filter with pre filter

Ultra-powerful: thanks to the 5-stage turbine

Quick-release coupling with integral swivel joint: for quick connection of the gun to the air hose

| TECHNICAL DATA | FINECOAT 9900 PLUS |
|--------------------------|---|
| Voltage | 230 V / 50 Hz |
| Motor output | 1.5 kW |
| Operating pressure, max. | 0.72 bar, 0.072 MPa |
| Weight | 15 kg |
| Scope of delivery | Base unit FineCoat 9900; Air hose; FineCoat gun, 1 litre pressure cup, incl. nozzle set No. 4 |
| Art. No. | 276048 |



PRACTICAL ACCESSORIES FOR XVLP AND HVLP TURBINES

| HVLP GUNS | Art. No. |
|--|----------|
| FineCoat Split Gun, gravity feed cup, 600 ml | 524053 |
| FineCoat Split Gun, suction cup, 1000 ml | 524028 |
| FineCoat Gun, pressure cup 1 litre, incl. nozzle kit no. 4 | 279094 |
| Conversion kit FC Split Gun to flow cup, 1000 ml | 524045 |
| Ultra Gun HVLP gun | 2435747 |
| WSL 50 Spraying Lance: Areas of application - Renovation and repair, ceiling and wall design; Material supply via commercially available pressure tank | 0261023 |
| Pressure tank, for HVLP guns, 2 litres | 524232 |

HVLP Split Gun – 600 ml flow cup – for wood & metal paints

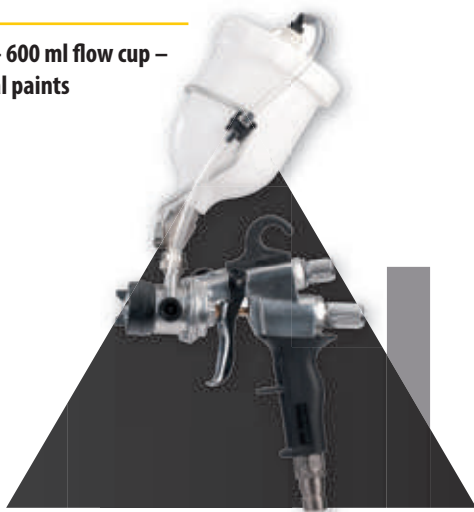

| XVLP FINISHCONTROL SPRAY ATTACHMENT | Art. No. |
|--|----------|
| FineSpray, for low-viscosity materials and glazes | 2430385 |
| StandardSpray, for all standard enamels | 2430386 |
| WallSpray, for emulsion and latex paints | 2430387 |
| Cup, 1400 ml | 2324749 |
| Cup, 1000 ml | 2434525 |
| Can Adapter, for adapting original containers to the spray attachments | 2350692 |

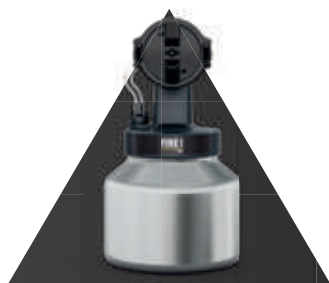

FineSpray spray attachment XVLP – for wood & metal paints

| XVLP OTHER | Art. No. |
|--|----------|
| Air filter, for FC 5500, 4 pieces | 2434505 |
| Air filter, for FC 3500, 3 pieces | 2343947 |
| Feed tube filter fine, red, 5 pieces | 2324248 |
| Feed tube filter coarse, white, 5 pieces | 2324249 |
| Cleaning brush set | 2430409 |

| FINECOAT HOSES | Art. No. |
|--|----------|
| Air hose complete, 9 m, for FC 9900 Plus | 277236 |
| Air hose complete, 7.6 m, for FC 9700 | 2424102 |
| Hose assembly, DN10, 8.2m, for FineCoat | 261255 |
| Hosw whip, 152 cm, for FineCoat | 0524405A |

Nozzle set – for different materials

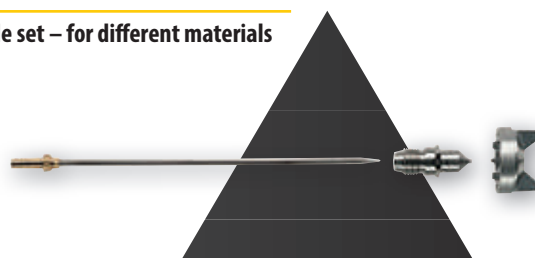

| HVLP NOZZLE SETS FOR FINECOAT GUN | Art. No. |
|-----------------------------------|----------|
| Nozzle set, No. 2, Ø 0.8 mm | 276254 |
| Nozzle set, No. 3, Ø 1.3 mm | 276227 |
| Nozzle set, No. 4, Ø 1.8 mm | 276228 |
| Nozzle set, No. 5, Ø 2.2 mm | 276229 |
| Nozzle set, No. 6, Ø 2.5 mm | 276245 |
| Nozzle set, No. 7, Ø 2.7 mm | 524211 |

| HVLP NOZZLE SETS FOR FINECOAT SPLIT GUN | Art. No. |
|---|----------|
| Nozzle set, No. 2, Ø 0.5 mm | 529209 |
| Nozzle set, No. 3, Ø 1.3 mm | 529210 |
| Nozzle set, No. 4, Ø 1.8 mm | 529211 |
| Nozzle set, No. 5, Ø 2.2 mm | 529212 |
| Nozzle set, No. 6, Ø 2.4 mm | 529213 |

| HVLP NOZZLE SETS FOR ULTRA GUN | Art. No. |
|--------------------------------|----------|
| Nozzle set, No. 2, Ø 0.8 mm | 2434549 |
| Nozzle set, No. 3, Ø 1.3 mm | 2434550 |
| Nozzle set, No. 4, Ø 1.8 mm | 2434551 |
| Nozzle set, No. 5, Ø 2.2 mm | 2434552 |
| Nozzle set, No. 6, Ø 2.5 mm | 2434553 |
| Nozzle set, No. 7, Ø 2.7 mm | 2434554 |

HEA – HIGH EFFICIENCY AIRLESS

Up to 55% less overspray with maximum control

Do you already value the advantages of airless technology, such as control and comfort? Then you'll be inspired by the new HEA ProTip airless nozzle from WAGNER. It achieves perfect surface results at a much lower spray pressure. Compared to conventional airless technology, you achieve a streak free coverage with softer spray edges.



More efficiency for prolonged working:

Thanks to the HEA nozzle technology, the spray pressure can be significantly lowered. This reduces the overspray by up to 55 percent*. Apart from reducing the amount of masking needed, this also has a positive effect on the gun's recoil. Working with a WAGNER airless pump is made even easier and more convenient with the HEA technology.

Robust and durable:

The nozzle wears more slowly due to the lower spray pressure. This means that HEA nozzles can be used for considerably longer than conventional airless nozzles. Loads on the pump are also reduced due to the lower pressure, with handling of the gun also improved.

1. MAXIMUM CONTROL:

The gentle spray pattern ensures a more even surface when overlapping the paths and avoids hard edges. This leads to a simple and easy-to-learn technique – even for inexperienced users.

2. PERFECT SURFACE QUALITY:

High Efficiency Airless ensures a uniform and even application on all surfaces and therefore offers excellent surface quality – especially when compared to conventional applications with a brush and roller.

3. INCREASED EQUIPMENT LIFESPAN:

Even the lifespan of the spray device itself is prolonged: the lower spraying pressure with High Efficiency Airless means that the system and its components are under less strain.



100 bar pressure
HEA ProTip 517

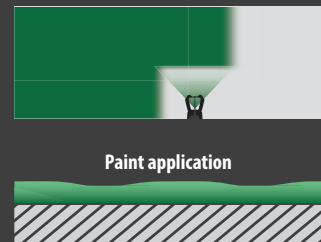

Paint application

Standard airless technology



150 bar pressure
Standard airless
nozzle 517

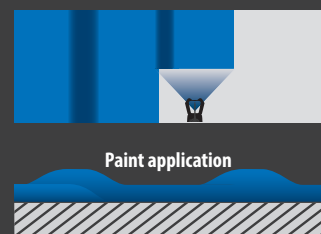

Paint application

*compared to other airless nozzles on the market

DIAPHRAGM PUMP

Effective material intake – broad range of materials

Do you want to process different materials, from primers to silicate paints with just one device? Then a WAGNER diaphragm pump is the ideal choice. This powerful, maintenance friendly technology transports the material via a lifting motion of the diaphragm. Diaphragm pumps from WAGNER are robust, easy-to-use construction site and workshop units.

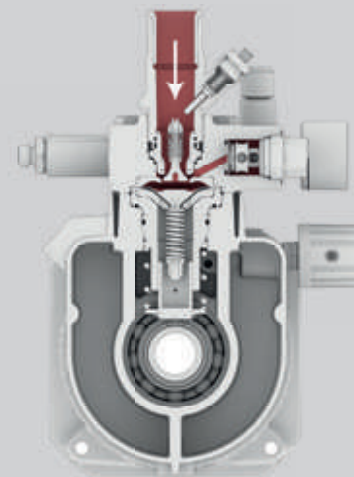

The perfect companion for painters and affiliated trades:

The patented Quality-Long-Stroke (QLS) technology from WAGNER, with its optimised hydraulics and special valve technology, means that the material is taken in much more effectively compared to diaphragm pumps from other manufacturers. As a result, a broad range of different materials, such as primers and release agents, primers and lacquers, emulsion and silicate paints, fabric adhesives, corrosion and flame retardants can be processed. In the domain of specially filled materials such as bitumen, fire protection and fillers, piston and spiral pumps are the specialists. Electrically operated diaphragm pumps can be used in both Airless and AirCoat processes with additional air atomization.

Fire retardants for joiners, metalworkers and similar trades:

Pneumatic double diaphragm pumps are ideal for the wood and metal processing industry. In this case, the material is transported via the lifting motion of two opposing diaphragm which generates a lower-pulsation material flow. This allows you to work with materials which are particularly sensitive to shearing and moisture and with premixed two-component materials. WAGNER double diaphragm pumps are explosion-proof and operated by compressed air, which means that they can be used safely in workshops and in painting booths.

1. ALSO SUITABLE FOR VERY SMALL VOLUMES:

Diaphragm pumps have up to 58 %* less material in their system. The device's small cross-sections means that it can also be operated with tiny amounts of material. This saves resources both when changing material and during the cleaning process.

2. LOW-MAINTENANCE AND DURABLE:

The reduced lifting frequency of the diaphragm means that the already lower number of wear parts are placed under significantly less stress. This significantly reduces maintenance costs*. However, should a repair be necessary, the corresponding components can be easily replaced directly on site and in the case of both valves for example, within minutes.

3. FINE AND EVEN SPRAY PATTERN:

Diaphragm technology reduces the pulsation of the material flow, which avoids any irregularities in the spray pattern, remaining uniform and even.

SPRAYPATTERN AT LOW PRESSURE



Piston pumps:
irregular spray pattern

Diaphragm pump:
even spray pattern

BENEFITS

- Large range of material
- Flexible material intake(also small quantities)
- Fully adjustable pressure regulation from 0 - 25 MPa
- QLS technology with longer stroke
- Very fine, even spray pattern
- Robust and very low-maintenance
- Simple maintenance
- Low noise

*compared to other piston pumps on the market

SUPERFINISH 23 PRO HEA SPRAYPACK

For perfect results with maximum control thanks to innovative airless diaphragm technology

- **Innovative HEA technology:** up to 55 % less overspray with maximum control
- **Flexible suction hose:** the diaphragm pump draws materials such as emulsions, latex paints or lacquers directly from the original container
- **For medium-sized emulsion jobs**
- **Compact:** with height-adjustable telescopic handle for easy transport and space-saving storage
- **Quality LongStroke Technology (QLS):** for a long service life, easy maintenance and low wear

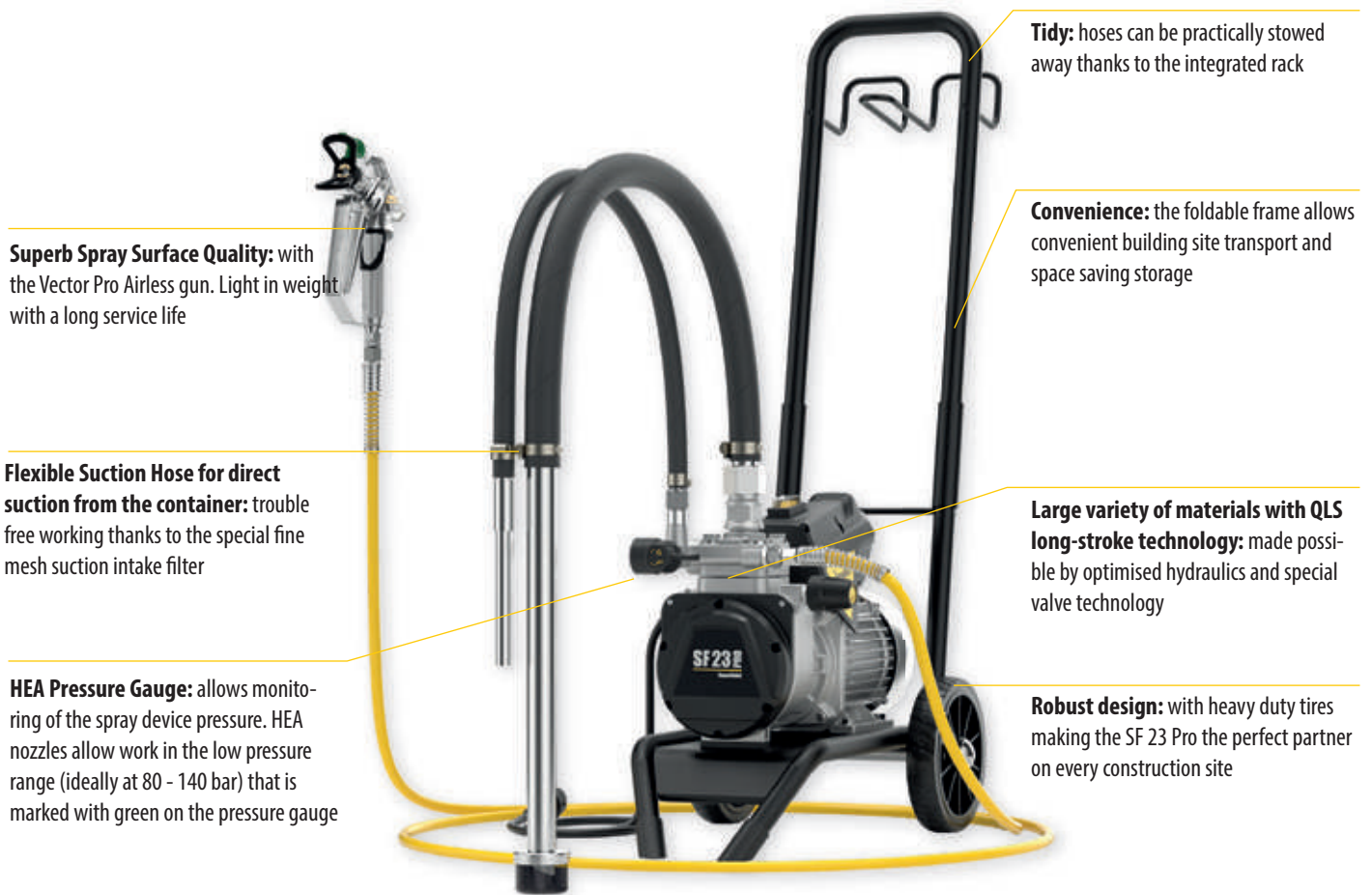

Superb Spray Surface Quality: with the Vector Pro Airless gun. Light in weight with a long service life

Flexible Suction Hose for direct suction from the container: trouble free working thanks to the special fine mesh suction intake filter

HEA Pressure Gauge: allows monitoring of the spray device pressure. HEA nozzles allow work in the low pressure range (ideally at 80 - 140 bar) that is marked with green on the pressure gauge

Tidy: hoses can be practically stowed away thanks to the integrated rack

Convenience: the foldable frame allows convenient building site transport and space saving storage

Large variety of materials with QLS long-stroke technology: made possible by optimised hydraulics and special valve technology

Robust design: with heavy duty tires making the SF 23 Pro the perfect partner on every construction site

| TECHNICAL DATA | SUPERFINISH 23 PRO HEA |
|-------------------------------|---|
| Voltage | 230 V / 50 Hz |
| Motor output | 1.3 kW |
| Operating pressure, max. | 250 bar, 25 MPa |
| Delivery rate, max. | 2.6 l/min |
| Nozzle size, max. | 0.023" |
| Recommended hose length, max. | 30 m |
| Viscosity, max. | 20.000 mPas |
| Weight | 27 kg |
| Scope of delivery | Base unit SF 23 Pro; HP hose DN6; Suction hose incl. return hose and filter; Airless gun Vector Pro; HEA ProTip 519; HEA pressure gauge set; Tool bag |
| Art. No. | 2399198 |



SUPERFINISH 23 PLUS HEA SPRAYPACK

Compact – light and yet robust

- **Innovative, low-pressure airless technology:** up to 55 % less overspray
- **Compact:** smallest in its class, mobile and light
- **For medium-sized emulsion jobs**
- **Robust:** ideal for demanding construction site use
- **PumpRunner:** perfect for clean, tidy transport



Large variety of materials with QLS long-stroke technology: the optimised hydraulics and special valve technology make it possible

Multifunction switch for extra safety: on/off as well as circulation and spray mode. This prevents accidental switching on or off while the system is under pressure

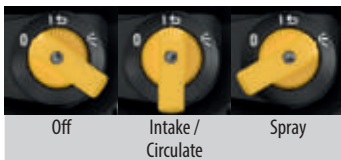

Superb spray surface quality: with the Vector Grip Airless gun. Light in weight with a long service life

Infinitely variable pressure regulation: from 0 to 250 bar

Direct suction: straight from the container for trouble-free working. Inclusive PumpRunner for clean transport included

| TECHNICAL DATA | SUPERFINISH 23 PLUS HEA |
|-------------------------------|--|
| Voltage | 230 V / 50 Hz |
| Motor output | 1.3 kW |
| Operating pressure, max. | 250 bar, 25 MPa |
| Delivery rate, max. | 2.6 l/min |
| Nozzle size, max. | 0.023" |
| Recommended hose length, max. | 30 m |
| Viscosity, max. | 20.000 mPas |
| Weight | 29 kg |
| Scope of delivery | Base unit SF 23 Plus; Suction system complete, incl. PumpRunner; HP hose DN6; Airless gun Vector Grip incl. TradeTip 3 nozzle holder; HEA ProTip 519; Gun filter white |
| Art. No. | 2384153 |

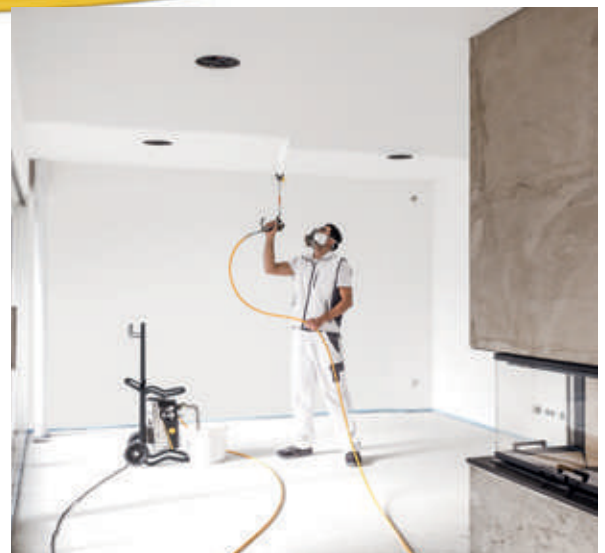

SUPERFINISH 23 PLUS AIRLESS ENAMEL SPRAYPACK

The perfect solution for small paint jobs using diaphragm technology

- **Entry-level Airless spraypack:** for painting objects
- **FineFinish painting:** with hopper and the special FineFinish nozzle
- **Straightforward handling and simple operation:** multifunction switch for greater safety - It is impossible to turn the unit on and off under pressure
- **Improved performance:** no-maintenance brushless motor

Superb spray surface quality: with the Vector Grip Airless gun. Light in weight with a long service life

Large variety of materials with QLS long-stroke technology: the optimised hydraulics and special valve technology make it possible

Infinitely variable pressure regulation: from 0 to 250 bar

Multifunction switch for extra safety: on/off as well as circulation and spray mode. This prevents accidental switching on or off while the system is under pressure

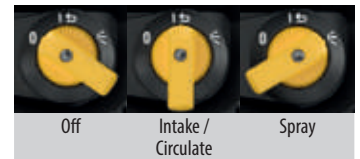

| TECHNICAL DATA | SUPERFINISH 23 PLUS AIRLESS ENAMEL |
|-------------------------------|---|
| Voltage | 230 V / 50 Hz |
| Motor output | 1.3 kW |
| Operating pressure, max. | 250 bar, 25 MPa |
| Delivery rate, max. | 2.6 l/min |
| Nozzle size, max. | 0.023" |
| Recommended hose length, max. | 30 m |
| Viscosity, max. | 20.000 mPas |
| Weight | 29 kg |
| Scope of delivery | Base unit SF 23 Plus; 5 litre hopper; HP hose DN3; Airless gun Vector Grip incl. TradeTip 3 nozzle holder; TradeTip 3 FineFinish nozzle 410; Gun filter red |
| Art. No. | 2341492 |



SUPERFINISH 23 PLUS TEMPSPRAY SPRAYPACK

Enamel specialist with heated hose

- **Perfect surface results:** thanks to heated hose
- **Also ideal for:** highly viscous materials such as enamels with high VOC content
- **The TempSpray system heats the material directly in the hose:** thereby ensuring perfect viscosity without the need for thinning, as well as optimum paint application



Superb Spray Surface Quality: with the Vector Grip Airless gun. Light in weight with a long service life

Perfect surface quality with Temp-Spray: thanks to warming up the coating material a very soft spray pattern is generated. This increases the atomisation quality. Further advantages are: reduced overspray, perfect viscosity without diluting and much more

Infinitely variable pressure regulation: from 0 to 250 bar

Large variety of materials with QLS long-stroke technology: the optimised hydraulics and special valve technology make it possible

Multifunction switch for extra safety: on/off as well as circulation and spray mode. This prevents accidental switching on or off while the system is under pressure

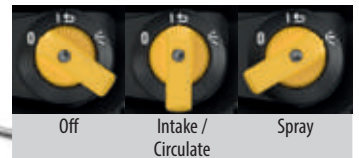

| TECHNICAL DATA | SUPERFINISH 23 PLUS TEMPSPRAY |
|-------------------------------|--|
| Voltage | 230 V / 50 Hz |
| Motor output | 1.3 kW |
| Operating pressure, max. | 250 bar, 25 MPa |
| Delivery rate, max. | 2.6 l/min |
| Nozzle size, max. | 0.023" |
| Recommended hose length, max. | 10 m |
| Viscosity, max. | 20.000 mPas |
| Weight | 29 kg |
| Scope of delivery | Base unit SF 23 Plus; 5 litre hopper; TempSpray H 126 base unit; Airless gun Vector Grip incl. TradeTip 3 nozzle holder; TradeTip 3 FineFinish nozzle 410 ; Gun filter red |
| Art. No. | 2341496 |



SUPERFINISH 23 PLUS AIRCOAT ENAMEL SPRAYPACK

Mobile complete solution for enamel work

- **With AirCoat technology:** particularly fine atomisation for a perfect finish
- **The industry standard:** quality-crafted by WAGNER
- **Perfectly matching components:** minimal overspray and high application efficiency
- **Suitable for:** non EX environments
- **Particularly easy handling**

Large variety of materials with QLS long-stroke technology: the optimised hydraulics and special valve technology make it possible

Ergonomic AirCoat gun AC 4600: the low air consumption and the soft spray pattern guarantee perfect painting results

Infinitely variable pressure regulation: from 0 to 250 bar

Multifunction switch for extra safety: on/off as well as circulation and spray mode. This prevents accidental switching on or off while the system is under pressure

AirBoost 100 compressor

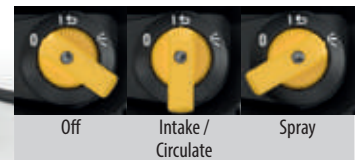

| TECHNICAL DATA | SUPERFINISH 23 PLUS AIRCOAT ENAMEL |
|-------------------------------|---|
| Voltage | 230 V / 50 Hz |
| Motor output | 1.3 kW |
| Operating pressure, max. | 250 bar, 25 MPa |
| Delivery rate, max. | 2.6 l/min |
| Nozzle size, max. | 0.023" |
| Recommended hose length, max. | 7.5 m |
| Viscosity, max. | 20.000 mPas |
| Weight | 29 kg |
| Scope of delivery | Base unit SF 23 Plus; 5 litre hopper; HP double hose; AirCoat gun AC 4600; Nozzle ACF3000; Air cap green; AirBoost 100 compressor; AirCoat regulator, fitting kit |
| Art. No. | 2353393 |



SUPERFINISH 23 CR

Professional injection and crack repair

- **Powerful:** big diaphragm surface for perfect usage with high viscosity materials and a long life time
- **Variety of materials:** suitable for Epoxy and Polyurethanes (PU), SPUR foam, aqueous solutions
- **Simple:** service, cleaning and maintenance directly on the job site is no problem at all
- **Ease of use:** handy pressure regulation in low pressure areas
- **Durable:** all wetted parts out of stainless steel

Inlet pusher valve: for a high operating reliability and easy commissioning. Just the press of a finger, and the valve is free

Pressure relief directly at the unit: stainless steel ball valve - especially for injection application

Fine adjustment: Smooth pressure regulation from 0-250 bar for all applications

Long-stroke technology from WAGNER: thanks to a low stroke frequency, the components are subjected to significantly less stress and thus offer a longer service life and lower maintenance costs

Modular variants: two-position cart for use with hopper, flexible and rigid suction system



Hopper for small quantities



Flexible suction system



Rigid suction system with rigid return hose



Rigid suction system with flexible return hose



Brushless motor: maintenance free and completely reliable

Easy to transport: robust cart with height-adjustable handle

| TECHNICAL DATA | SUPERFINISH 23 CR |
|-------------------------------|---|
| Voltage | 230 V / 50 Hz |
| Motor output | 1.3 kW |
| Operating pressure, max. | 250 bar, 25 MPa |
| Delivery rate, max. | 2.6 l/min |
| Nozzle size, max. | - |
| Recommended hose length, max. | 15 m |
| Viscosity, max. | 20.000 mPas |
| Weight | 29 kg |
| Scope of delivery | Base unit SF 23 CR on cart; Pressure gauge set HEA (MPa) |
| Art. No. | 2415601 |

| ACCESSORIES FOR INJECTION WORK | Art. No. |
|--|----------|
| Hose whip with mouthpiece | 2434357 |
| Hopper 5 litre, M36x2 | 2357506 |
| Suction system, flexible | 2393123 |
| Suction system, rigid, with flexible return hose | 2405950 |
| Suction system, rigid, with rigid return hose | 2429697 |
| Airless gun AG 14, G-thread 1/4", incl. TradeTip 3 nozzle holder | 0502081A |



SUPERFINISH 33 PRO SPRAYPACK

One diaphragm pump for every project – outstanding performance for in- and outdoor application

- **Versatile applications:** the SuperFinish 33 Pro can process a diverse range of materials and service a wide variety of industries and project sizes
- **Optimum efficiency and productivity:** with a delivery rate of 4.3 litres per minute, the SuperFinish 33 Pro is the most powerful WAGNER diaphragm pump in the professional segment
- **Quality LongStroke Technology (QLS):** for a long service life, easy maintenance and low wear
- **Practical multi-gun operation:** for parallel use, a distributor adapter for connecting up to three airless guns is available separately as an accessory



| TECHNICAL DATA | SUPERFINISH 33 PRO |
|-------------------------------|---|
| Voltage | 230 V / 50 Hz |
| Motor output | 2.2 kW |
| Operating pressure, max. | 250 bar, 25 MPa |
| Delivery rate, max. | 4.3 l/min |
| Nozzle size, max. | 0.033" |
| Recommended hose length, max. | 60 m |
| Viscosity, max. | 25.000 mPas |
| Weight | 43 kg |
| Scope of delivery | Base unit SF 33 Pro; Suction system, flexible; Hp hose DN6; Airless gun Vector Pro incl. TradeTip3 nozzle holder; HEA ProTip nozzle 521 |
| Art. No. | 2388260 |



SUPERFINISH 33 PLUS SPRAYPACK

The extremely easy-to-use diaphragm pump for every project

- **Versatile applications:** the SuperFinish 33 Plus can process a diverse range of materials and service a wide variety of industries and project sizes
- **Optimum efficiency and productivity:** with a delivery rate of 4.3 litres per minute, the SuperFinish 33 Plus is the most powerful WAGNER diaphragm pump in the professional segment
- **Practical multi-gun operation:** for parallel use, a distributor adapter for connecting up to three airless guns is available separately as an accessory
- **Flexible use:** switch the pump position with a single hand movement from working with the top container to the rigid suction system with fine filter meshes

Ergonomic working: with the high quality Vector Grip Airless gun. It is light, robust and highly ergonomic

Modular variants: two-position cart for use with the top container or rigid suction system



Robust, building-site-friendly tires: allow easy transport across even the most challenging terrain

Integrated toolbox: including a handy organiser to ensure the right tools and accessories are always at hand



Includes a handy 230 V socket: to connect additional devices, such as TempSpray

Inlet pusher valve: for a high operating reliability and easy commissioning. Just the press of a finger, and the valve is free

Illuminated multifunction switch for extra safety: on/off as well as circulation and spray mode. This prevents accidental switching on or off while the system is under pressure

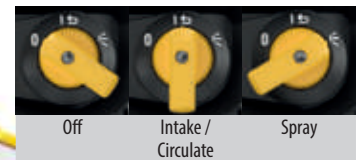

Direct suction: straight from the container for trouble-free working – thanks to the special filter with ultra-fine filter mesh

| TECHNICAL DATA | SUPERFINISH 33 PLUS |
|-------------------------------|--|
| Voltage | 230 V / 50 Hz |
| Motor output | 2,2 kW |
| Operating pressure, max. | 250 bar, 25 MPa |
| Delivery rate, max. | 4,3 l/min |
| Nozzle size, max. | 0,033" |
| Recommended hose length, max. | 60 m |
| Viscosity, max. | 25.000 mPas |
| Weight | 50 kg |
| Scope of delivery | Base unit SF 33 Plus; Suction system, rigid; HP hose DN6; Airless gun Vector Grip incl. TradeTip3 nozzle holder; HEA ProTip nozzle 521 |
| Art. No. | 2388259 |



PRACTICAL ACCESSORIES FOR ELECTRIC DIAPHRAGM PUMPS

ENAMEL KIT (DN4) FOR ALL SUPERFINISH PUMPS

Suitable for SF 23 Plus, SF 33, SF 27, SF 31.

- HP hose DN4, NPSM 1/4", max 27 MPa / 270 bar, 7.5 m
- Vector Pro gun
- Nozzle extension, G-thread, 15 cm
- FineFinish TT3 nozzle 308 (Lack)
- FineFinish TT3 nozzle 412 (Füller)
- TipClean 200 ml
- Gun filter, red, extra fine, 10 pieces
- Hopper 5 litre, M36 x 2

| SPRAYKIT | Art. No. |
|------------------|----------|
| Enamel Kit (DN4) | 2406207 |



HEA KIT (DN6) FOR ALL PUMPS WITH 1/4" CONNECTORS

Suitable for all SuperFinish and ProSpray pumps, as well as PowerPainter 90

- HP hose DN6; NPSM 1/4"; max. 27 MPa / 270 bar; 15 m
- Vector Pro gun
- Nozzle extension, G-thread, 15 cm
- HEA ProTip nozzle 517
- HEA ProTip nozzle 311
- TipClean 200 ml
- Gun filter, white, medium, 10 pieces

| SPRAYKIT | Art. No. |
|---------------|----------|
| HEA Kit (DN6) | 2408212 |



2GUN KIT – CONNECTION OF UP TO THREE GUNS ON ONE DEVICE

Suitable for: all Heavy Coat pumps, SF33 as well as PS 3.31 upwards.

- Adapter for multi-gun operation (for max. 3 guns)
- Vector Grip gun
- HP hose DN6, NPSM 1/4", 15 m, max. 27 MPa / 270 bar, 15 m
- Double connector NPSM 1/4"

| SPRAYKIT | Art. No. |
|----------|----------|
| 2Gun Kit | 2413598 |



| AIRCOAT ACCESSORIES | Art. No. |
|---|----------|
| AirCoat gun AC 4500, incl. blue air cap and holder | 2368269 |
| AirCoat nozzles ACF 3000; different sizes | 379xxx |
| HP double hose, material DN3, max. 27 MPa, air DN6, 1/4", 7.5 m | 9984595 |
| Air cap blue, incl. union nut | 394911 |
| Air cap green, incl. union nut | 394912 |
| Air cap red, incl. union nut | 394910 |
| Union nut, complete | 394921 |
| Compressor AirBoost 100 | 2347935 |
| AirCoat regulator, fitting kit | 340250 |

| HOPPER | Art. No. |
|--|----------|
| Hopper 20 litre, M36x2, for SuperFinish | 341266 |
| Hopper 5 litre, M36x2, for SuperFinish | 341265 |
| Hopper 5 litre, with TopClean, for SuperFinish | 341268 |

NOTES

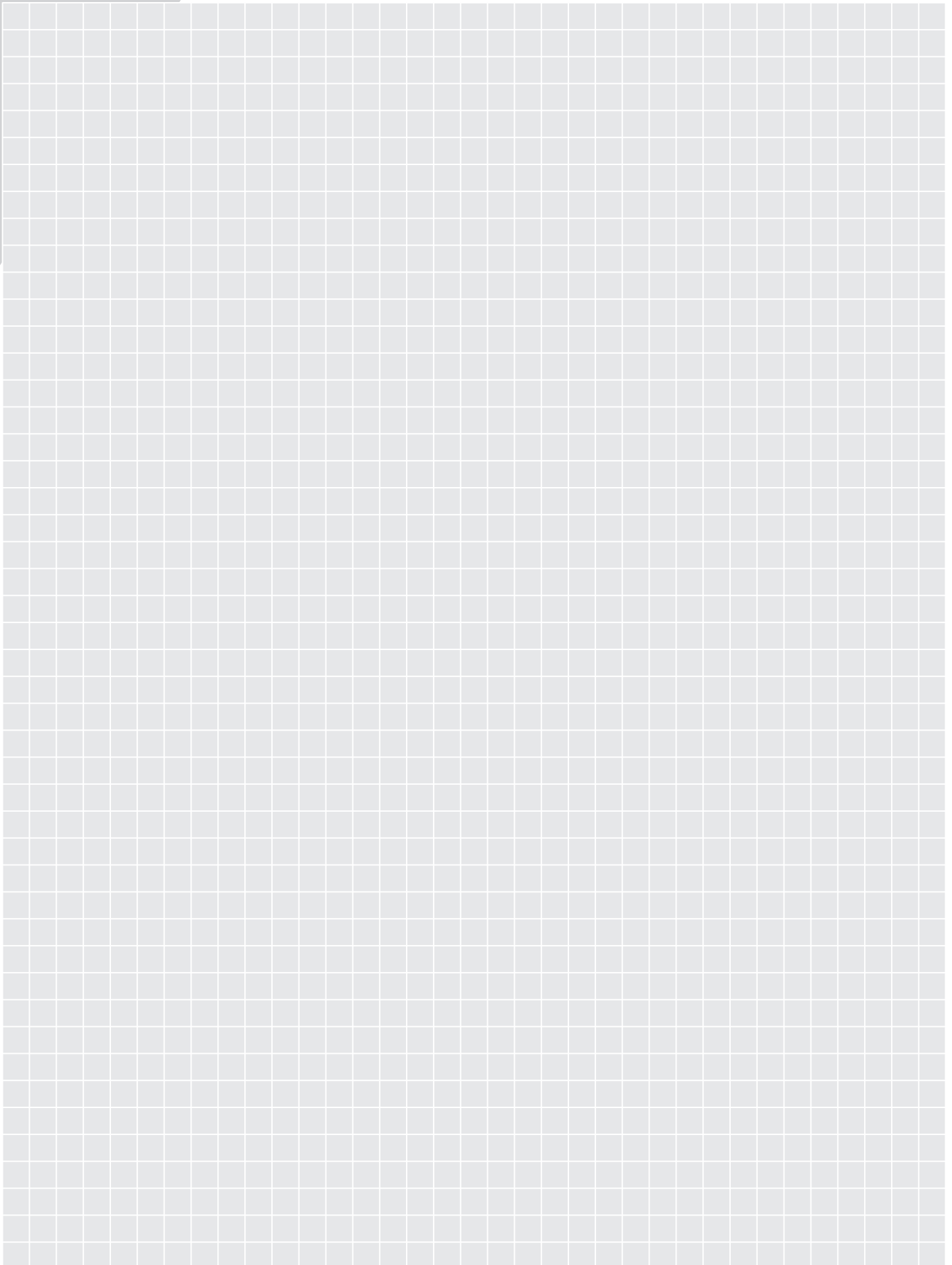

ELECTRIC PISTON PUMPS

Especially high suction and delivery performance – across the range

Do you mostly work with viscose or filler materials? Then an electric WAGNER piston pump is the best support for you. The high suction power produced by the piston's lifting motion makes it ideal for this type of material.

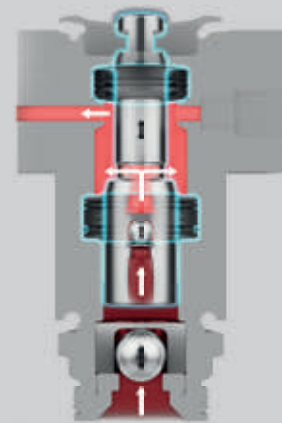

Various performance classes for professional and semi-professional users:

With the third generation of piston pumps from WAGNER, you have a choice of machines for large or small sites. They cover a broad range of paints and emulsions - right through to high-viscosity and filler materials for interior and exterior use.

A powerful companion - inside and out:

WAGNER piston pumps are available with three different drive systems. Electric piston pumps cover a wide range of performance classes and have a compact design. The hydraulic piston pumps offer even better performance and are available with a choice of either a petrol or an electric motor which can be switched in a few minutes. Pneumatically driven piston pumps from WAGNER are explosion-proof and therefore are suitable for use in workshops.

1. BRUSHLESS MOTOR:

Brushless motors are a real benefit for this device, especially in terms of its long service life. Alongside its efficient mode of working, its key advantages include a constantly high torque with low power consumption and reduced heat generation.

2. NO CONTINUOUS RUNNING:

Piston pumps only operate when you have to build up pressure. The rest of the time, the drive is on 'standby'. This protects wear parts and has a positive impact on site noise levels.

CROSS-SECTION OF THE PISTON

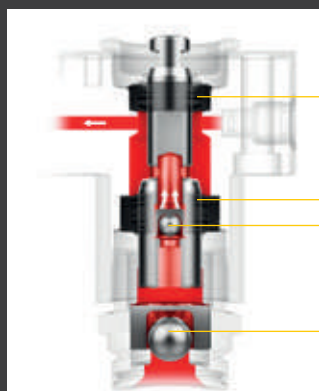

Upper packing

Lower packing
Outlet valve

Inlet valve

ADVANTAGES

- Powerful suction
- Better delivery capacity with high viscosity materials
- Less sensitive to filled materials
- Large nozzle sizes can be used
- Extra-durable packing

POWERPAINTER 90 EXTRA SPRAYPACK

Fast, clean, perfect – the airless paint spraying system for small projects

- **Innovative, high-efficiency airless technology (HEA):** the HEA ProTip nozzle ensures up to 55 % less overspray, as well as a longer service life thanks to reduced spray pressure
- **Easy painting:** noticeably easier paint application thanks to a soft spraying pattern with maximum control
- **Direct suction from the original container:** the airless paint spraying system extracts materials directly out of the paint bucket or varnish container

Comfortable: the adjustable telescopic handle allows convenient transport on the construction site as well as space-saving storage

Pressure gauge: allows the perfect control of pressure in coordination with the material being processed

DN6, 15 m high-pressure hose: for a large radius of action

Integrated storage box: ideal for storing tools and accessories

Innovative HEA nozzle technology: two nozzle orifices, one directly in front of the other, guarantee a perfect spray pattern with high material throughput even in low pressure ranges

Lightweight airless gun with four-finger trigger: for fatigue-free and safe work

Double-Acting-piston pump: for consistent material feed

Inlet pusher valve: for a high operating reliability and easy commissioning. Just the press of a finger, and the valve is free

Also available as skid-version



| TECHNICAL DATA | POWERPAINTER 90 EXTRA SKID | POWERPAINTER 90 EXTRA CART |
|-------------------------------|--|--|
| Voltage | 230 V / 50 Hz | 230 V / 50 Hz |
| Motor output | 0.8 kW | 0.8 kW |
| Operating pressure, max. | 200 bar, 20 MPa | 200 bar, 20 MPa |
| Delivery rate, max. | 1.9 l/min | 1.9 l/min |
| Nozzle size, max. | 0.019" | 0.019" |
| Recommended hose length, max. | 15 m | 15 m |
| Weight | 10.2 kg | 25.2 kg |
| Scope of delivery | Base unit PowerPainter 90 Extra; Airless gun Vector Pro incl. TradeTip3 nozzle holder; HP hose DN6; HEA pressure gauge; HEA ProTip nozzle 517; EasyGlide special oil | Base unit PowerPainter 90 Extra; Airless gun Vector Pro incl. TradeTip3 nozzle holder; HP hose DN6; HEA pressure gauge; HEA ProTip nozzle 517; EasyGlide special oil |
| Art. No. | 2414079 | 2401275 |

PROSPRAY 3.20 HEA SPRAYPACK

The compatible piston pump for airless beginners

- **Robust and simple:** perfect for use on the construction locations, reliable, easily accessible high quality packings
- **Good performance at an attractive price:** for medium-sized projects, ideal for interior emulsion paints
- **Innovative, low-pressure airless technology:** up to 55 % less overspray due to HEA technology
- **With flexible suction system:** for simple intake directly from the original container
- **Well-proven piston pump:** ideal for comfortable transport and space-saving storage



Included: tool bag with two spanners

HEA 517 nozzle: for a soft spray pattern and up to 55 % less overspray

User-friendly: easy to operate and a reduced number of settings options makes starting up the sprayer easier

HEA pressure gauge: a longer service life thanks to innovative HEA low-pressure airless technology

Hose wrap: for optimised storage of the hose

Inlet pusher valve: for a high operating reliability and easy commissioning. Just the press of a finger, and the valve is free

Double-acting-piston pump: for consistent material feed

| TECHNICAL DATA | PROSPRAY 3.20 HEA |
|-------------------------------|---|
| Voltage | 230 V / 50 Hz |
| Motor output | 1.3 kW |
| Operating pressure, max. | 207 bar, 20.7 MPa |
| Delivery rate, max. | 2 l/min |
| Nozzle size, max. | 0.021" |
| Recommended hose length, max. | 30 m |
| Viscosity, max. | 20.000 mPas |
| Weight | 13.6 kg |
| Scope of delivery | Base unit ProSpray 3.20; HP hose DN6; Flexible suction system; Pressure gauge set HEA; Airless gun Vector Pro incl. TradeTip 3 nozzle holder; HEA ProTip nozzle 517 |
| Art. No. | 2412438 |



PROSPRAY 3.21 HEA SPRAYPACK

Small and compact – for small object sizes

- **Innovative, low-pressure airless technology:** up to 55 % less overspray
- **Optimum value-for-money:** ideal for all users who mostly spray-coat small surfaces on a daily basis
- **For trouble-free operation:** integrated high-pressure filter
- **Compact design with outstanding performance**
- **data:** 0.023" nozzle size, 2.0 l/min max., delivery rate: 16 kg weight
- **With flexible suction system:** for simple intake directly from the original container



Maintenance made easy: with the push of a button the piston is oiled and thus the packings are conserved

HEA pressure gauge: a longer service life thanks to innovative HEA low-pressure airless technology

HEA 517 nozzle: for a soft spray pattern and up to 55 % less overspray

Compact: for easy transportation and space-saving storage

DN6, 15 m high-pressure hose: for a large radius of action

Inlet pusher valve: for a high operating reliability and easy commissioning. Just the press of a finger, and the valve is free

| TECHNICAL DATA | PROSPRAY 3.21 HEA |
|-------------------------------|---|
| Voltage | 230 V / 50 Hz |
| Motor output | 1.035 kW |
| Operating pressure, max. | 221 bar, 22.1 MPa |
| Delivery rate, max. | 2 l/min |
| Nozzle size, max. | 0.023" |
| Recommended hose length, max. | 30 m |
| Viscosity, max. | 20.000 mPas |
| Weight | 17.9 kg |
| Scope of delivery | Base unit ProSpray 3.21; HP hose DN6; Flexible suction system; Pressure gauge set HEA; Airless gun Vector Pro incl. TradeTip 3 nozzle holder; HEA ProTip nozzle 517 |
| Art. No. | 532089 |



PROSPRAY 3.25 SPRAYPACK

A compact emulsion unit for medium-sized objects

- **Electronic control, information and management directly on the device:** displays the current pressure, pressure settings can be set and displayed, and much more.
- **Easy to handle:** compact design for ease of transport and space-saving storage
- **Lightweight:** just 27.4 kg
- **No-maintenance brushless motor**

Clearly arranged - DESC-Control:

with the digital display you can read out and handle machine data, consumption figures, runtimes and much more. The intelligent deadband control, SlowMotion function and FrequentClean guarantee trouble-free work and quick cleaning

Maintenance-free, brushless

direct current motor: due to the improved performance, the motor works even more efficiently at low and also at high speeds. The continuous paint pressure measurement controls the motor speed automatically, thus ensuring a constant material pressure



HEA nozzle: for a soft spray pattern and up to 55 % less overspray

Superb spray surface quality: with the Vector Grip Airless gun. Light in weight with a long service life

Maintenance made easy: with the push of a button the piston is oiled and thus the packings are conserved

Inlet pusher valve: for a high operating reliability and easy commissioning. Just the press of a finger, and the valve is free

TECHNICAL DATA

PROSPRAY 3.25

| | |
|-------------------------------|---|
| Voltage | 230 V / 50 Hz |
| Motor output | 1.1 kW |
| Operating pressure, max. | 221 bar, 22.1 MPa |
| Delivery rate, max. | 2.6 l/min |
| Nozzle size, max. | 0.027" |
| Recommended hose length, max. | 30 m |
| Viscosity, max. | 25.000 mPas |
| Weight | 27.4 kg |
| Scope of delivery | Base unit ProSpray 3.25; HP hose DN6; Airless gun Vector Grip incl. TradeTip 3 nozzle holder; HEA ProTip nozzle 519 |
| Art. No. | 2308260 |



PROSPRAY 3.31 SPRAYPACK

A reliable unit for large-area emulsion work

- **Electronic control, information and management directly on the device:** displays the current pressure, pressure settings can be set and displayed, and much more.
- **No-maintenance brushless motor**
- **High coverage performance together with easy operation**
- **Innovative ProSpray product features:** digital information readout and unit control directly on the device - tilting carriage - integrated high-pressure filter - and more



Superb spray surface quality: with the Vector Grip Airless gun. Light in weight with a service life

Clearly arranged - DESC-Control: with the digital display you can read out and handle machine data, consumption figures, runtimes and much more. The intelligent deadband control, SlowMotion function and FrequentClean guarantee trouble-free work and quick cleaning

No nozzle blockages: the high pressure filter is easily accessible and quick to clean. Three different filter inserts (fine, medium, coarse) ensure an optimal match with the material

Tilting cart: fast change of the container. Site-optimised tires allow convenient pump transport

Maintenance-free, brushless direct current motor: due to the improved performance, the motor works even more efficiently at low and also at high speeds. The continuous paint pressure measurement controls the motor speed automatically, thus ensuring a constant material pressure

| TECHNICAL DATA | PROSPRAY 3.31 |
|-------------------------------|---|
| Voltage | 230 V / 50 Hz |
| Motor output | 1.84 kW |
| Operating pressure, max. | 221 bar, 22.1 MPa |
| Delivery rate, max. | 3.8 l/min |
| Nozzle size, max. | 0.032" |
| Recommended hose length, max. | 60 m |
| Viscosity, max. | 25.000 mPas |
| Weight | 43.5 kg |
| Scope of delivery | Base unit ProSpray 3.31; HP hose DN6; Airless gun Vector Grip incl. TradeTip 3 nozzle holder; HEA ProTip nozzle 521 |
| Art. No. | 2308262 |



PROSPRAY 3.39 SPRYPACK

Powerful emulsion unit for large areas

- **More power:** greater suction performance thanks to the low position of the suction valve
- **Twice as fast with emulsion:** parallel two-gun operation possible
- **The most powerful pump in the ProSpray family:** even able to cope with Airless spraying fillers
- **Innovative ProSpray product features:** tilting cart - change paints without using tools

Superb spray surface quality: with the Vector Grip Airless gun. Light in weight with a long service life

No nozzle blockages: the high pressure filter is easily accessible and quick to clean. Three different filter inserts (fine, medium, coarse) ensure an optimal match with the material

Tilting cart: fast change of the container. Site-optimised tires allow convenient pump transport

Clearly arranged - DESC-Control: with the digital display you can read out and handle machine data, consumption figures, runtimes and much more. The intelligent deadband control, SlowMotion function and FrequentClean guarantee trouble-free work and quick cleaning

Maintenance-free, brushless direct current motor: due to the improved performance, the motor works even more efficiently at low and also at high speeds. The continuous paint pressure measurement controls the motor speed automatically, thus ensuring a constant material pressure

Low maintenance costs: the practical, self-adjusting packings lead to less wear and are easy to change. They have a service life up to 50% longer than comparable packings

Also available as filler version with Airless gun AG 19 Art. No. 2308264



| TECHNICAL DATA | PROSPRAY 3.39 |
|-------------------------------|---|
| Voltage | 230 V / 50 Hz |
| Motor output | 2.19 kW |
| Operating pressure, max. | 221 bar, 22.1 MPa |
| Delivery rate, max. | 5 l/min |
| Nozzle size, max. | 0.039" |
| Recommended hose length, max. | 360 m |
| Viscosity, max. | 30.000 mPas |
| Weight | 50 kg |
| Scope of delivery | Base unit ProSpray 3.39; HP hose DN6; Airless gun Vector Grip incl. TradeTip 3 nozzle holder; HEA ProTip nozzle 519; Double connector A = 1/4" NPS x 3/8" NPT; Double connector A = 3/8" NPT x A = 1/2" NPS |
| Art. No. | 2351261 |



PRACTICAL ACCESSORIES FOR ELECTRIC PISTON PUMPS

ENAMEL KIT (DN4) FOR PROSPRAY PUMPS

Suitable for PS 20, PS 3.20, PS 3.21, PS 3.25 - Skid version.

- HP hose DN4, NPSM 1/4", max 27 MPa / 270 bar, 7.5 m
- Vector Pro gun
- Nozzle extension, G-thread, 15 cm
- FineFinish TT3 nozzle 308 (enamel)
- FineFinish TT3 nozzle 412 (filler)
- TipClean 200 ml
- Gun filter, red, extra fine, 10 pieces
- Hopper 5 litre, for ProSpray
- Hopper, filter package

| SPRAYKIT | Art. No. |
|------------------|----------|
| Enamel Kit (DN4) | 2406206 |



| HOPPER | Art. No. |
|---|----------|
| Hopper, 5 litre, for PowerPainter 90 Extra | 2423122 |
| Hopper, 5 litre, for ProSpray 3.20, 20, 3.21, 3.25 Skid version | 704-453 |

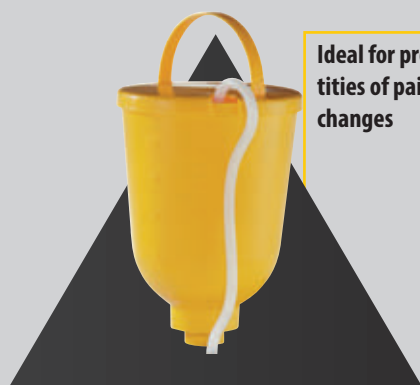

Ideal for processing smaller quantities of paint or frequent material changes

2GUN KIT – CONNECTION OF UP TO THREE GUNS ON ONE DEVICE

Suitable for: all Heavy Coat pumps, SF33 as well as PS 3.31 upwards.

- Adapter for multi-gun operation (for max. 3 guns)
- Vector Grip gun
- HP hose DN6, NPSM 1/4", 15 m, max. 27 MPa / 270 bar, 15 m
- Double connector NPSM 1/4"

| SPRAYKIT | SPRAYKIT |
|----------|----------|
| 2Gun Kit | 2413598 |



| HOSE REEL | Art. No. |
|--|----------|
| Hose reel HR45, incl. 30 m HP hose DN6, for all diaphragm and piston pumps | 341912 |



Hose reel HR45 with hose, suitable for all diaphragm and piston pumps

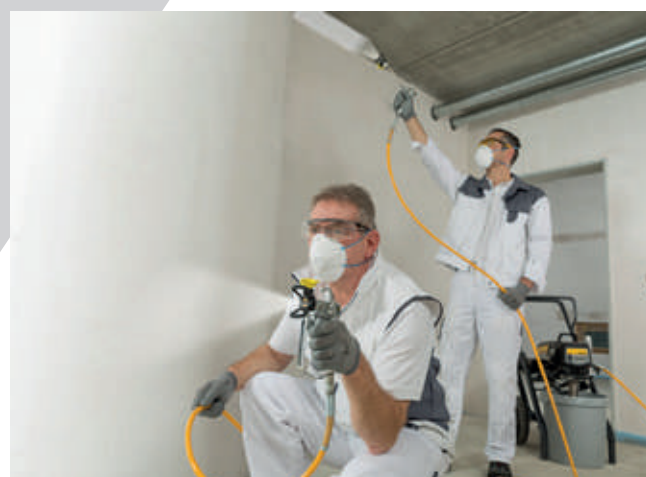

HYDRAULIC PISTON PUMP

Even more power for suction and delivery – with denser materials

Do you mostly work with particularly high-viscosity or very dense materials? Then a WAGNER piston pump is the perfect, reliable site companion for you. The exceptionally high suction and transport power is produced by the piston's stroke movement. This is amplified even further by the hydraulic drive and is particularly ideal for this type of material.



Various performance classes for every professional:

the especially reliable hydraulic pump technology from WAGNER is most suited to large construction sites, with a broad spectrum of applications from building protection and emulsion through to especially high-viscosity and very dense materials for use inside and out.

A powerful companion - inside and out:

WAGNER piston pumps are available with three different drive systems. Electric piston pumps cover a wide range of performance classes and have a compact design. The hydraulic piston pumps offer even better performance and are available with a choice of either a petrol or an electric motor which can be switched in a few minutes. Pneumatically driven piston pumps from WAGNER are explosion-proof and therefore are suitable for use in workshops.

1. WITH EVEN MORE POWER ON THE CONSTRUCTION SITE:

The patented SSP (Special Spray Power) system from WAGNER is a technology that is unique on the market for the application of high viscosity materials. The special design of the system ensures that the pump is continually filled with sufficient material by the shovel piston. SSP is available for all HeavyCoat models.



Additional power "Special-Spray-Power" for high viscosity materials

2. NO CONTINUOUS RUNNING:

Piston pumps only operate when you have to build up pressure. The rest of the time, the drive is on 'standby'. This protects wear parts and has a positive impact on site noise levels.

CROSS-SECTION OF THE PISTON

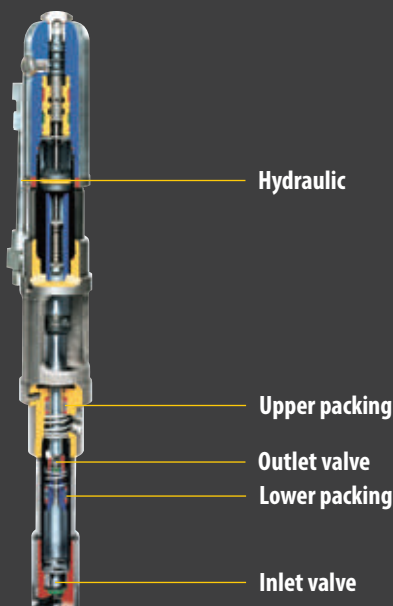

ADVANTAGES

- Better delivery capacity with extreme high viscosity materials
- Less sensitive to heavily filled materials
- High material pressure / material volume allow long hose lengths
- Large nozzle sizes can be used
- Extra-durable packing
- Powerful suction
- Convertible to SSP for additional power

HEAVYCOAT 750 SPRAYPACK

Compact power pack for heavy material

- **Long service and reliability:** thanks to Hydrastroke technology, the operating temperature is significantly reduced, thereby increasing the service life
- **New hydraulic design:** inspired by mining and aviation for the toughest demands in terms of the piston pump's working and delivery performance
- **Powerful:** constant performance for the application of heavy, filled and high-viscosity materials such as bitumen and textured plaster over large areas
- **Superb performance and perfect surface results:** even with long hoses
- **Maximum user-friendliness:** thanks to simple operation

Hydrastroke technology: the operating temperature is reduced by up to 14 °C in comparison to previous hydraulic systems

Ease of maintenance: pump and motor are easily accessible and the lower pump can be removed by loosening just 4 screws. This makes the HC 750 particularly maintenance friendly

Ideal cooling: the robust design of the housing cover with integrated ventilation slots conducts air over all device components that convey hydraulic fluid

Low valve or optionally selectable SSP shovel piston: enable processing of extremely high-viscosity materials

High pressure filter: for high reliability and minimal downtime

Quality spraying: with the high-performance gun AG 14. When used in combination with the 2SpeedTip nozzle for fillers, it is possible to handle even high-viscosity material without difficulty

Available as an electrically driven or petrol-driven model: the basic model without SSP is also available with a petrol motor. This means that it can also be used on construction sites without an electrical connection

Large pneumatic tires: mean that the unit is easy and comfortable to transport, even on difficult terrain



| TECHNICAL DATA | HEAVYCOAT 750 E | HEAVYCOAT 750 G | HEAVYCOAT 750 E SSP |
|------------------------------|---|-----------------|---|
| Voltage | 230 V / 50 Hz | - | 230 V / 50 Hz |
| Motor output | 3.1 kW | 4.1 kW | 3.1 kW |
| Operating pressure, max. | 250 bar, 25 MPa | 250 bar, 25 MPa | 250 bar, 25 MPa |
| Delivery rate, max. | 6 l/min | 7.6 l/min | 6 l/min |
| Nozzle size, max. | 0.043" | 0.041" | 0.043" |
| Recommended max. hose length | 100 m | 100 m | 100 m |
| Viscosity, max. | 50.000 mPas | 65.000 mPas | 50.000 mPas |
| Weight | 85 kg | 81 kg | 87 kg |
| Scope of delivery | Base unit HeavyCoat 750 E / G; HP hose DN13; Hose whip DN10; Connector I = 1/4"NPSM x A = 3/8"NPSM; 27 MPa; Airless gun AG 14 incl. TradeTip 3 nozzle holder; TradeTip 3 nozzle 539 | | Base unit HeavyCoat 750 E SSP; HP hose DN13; Hose whip DN10; Connector 3/8" x 1/2"; Airless gun AG 14 incl. TradeTip 3 nozzle holder; TradeTip 3 nozzle 539 |
| Art. No. | 2371027 | 2371029 | 2371028 |

HEAVYCOAT 950 SPRAYPACK

Power pack for the heaviest material

- **Versatile in use:** thanks to high delivery capacity
- **Powerful but light:** compact for ease of transport
- **Innovative HeavyCoat product features:** fast container changeovers, easy to clean and transport thanks to the swivelling SwingCart pump unit
- **SSP version:** with shovel piston for extra performance with high viscosity materials

Quality spraying: with the professional gun AG 14 and the TradeTip 3 nozzle for filler, high-viscosity materials can be processed without any problems

Swing-Cart: makes it possible to swing up the pump. Practical when working from a bucket or a container but also for transport

Tidied up: with the integral support hoses up to a length of 60 m can be practically stowed away

In a single action: the unit can be safely depressurised and quickly cleaned

Convenience: the adjustable height telescopic handle makes for convenient transport on the building site or in the in a vehicle

HeavyCoat special hose: with a 3/8", 1/2" or 3/4" cross section for a better spraying performance

High pressure filter: for high reliability and minimal downtime

You have the choice: with or without SSP shovel piston for processing of very high-viscosity materials



| TECHNICAL DATA | HEAVYCOAT 950 E | HEAVYCOAT 950 G | HEAVYCOAT 950 E SSP |
|------------------------------|---|-----------------|---|
| Voltage | 230 V / 50 Hz | - | 230 V / 50 Hz |
| Motor output | 3.6 kW | 4.1 kW | 3.6 kW |
| Operating pressure, max. | 250 bar. 25 MPa | 250 bar. 25 MPa | 250 bar. 25 MPa |
| Delivery rate, max. | 6.6 l/min | 8 l/min | 6.6 l/min |
| Nozzle size, max. | 0.052" | 0.041" | 0.052" |
| Recommended max. hose length | 100 m | 100 m | 100 m |
| Viscosity, max. | 50.000 mPas | 65.000 mPas | 50.000 mPas |
| Weight | 83 kg | 76 kg | 84.5 kg |
| Scope of delivery | Base unit HeavyCoat 950 E / G; HP hose DN10; Connector I = 1/4"NPSM x A = 3/8"NPSM; Airless gun AG 14 incl. TradeTip 3 nozzle holder; TradeTip 3 nozzle 443 | | Base unit HeavyCoat 950 E SSP; HP hose DN13; Hose whip DN10; Connector 3/8" x 1/2"; Airless gun AG 19 incl. TradeTip 3 nozzle holder; TradeTip 3 nozzle 443 |
| Art. No. | 2332184 | 2332186 | 2332187 |

HEAVYCOAT 970 SPRAYPACK

All-round Xtra speed for XL projects

- **WAGNERs most powerful hydraulic piston pump** more power with SSP
- **The perfect choice:** for large areas and intensive usage
- **Maximised capacity:** with a delivery volume of 10-12 l/min
- **Innovative HeavyCoat product features:** with a choice of either a petrol or electric motor which can be interchanged in a few minutes – or optionally even **SSP version:** with shovel piston for extra performance with high viscosity materials

Quality spraying: with the professional gun AG 14 and the TradeTip 3 nozzle for filler, high-viscosity materials can be processed without any problems

Swing-Cart: makes it possible to swing up the pump. Practical when working from a bucket or a container but also for transport.

Tidied up: with the integral support hoses up to a length of 60 m can be practically stowed away.

With a choice of electric drive or independent of mains electricity with the Honda petrol engine: the units can be converted from electric to petrol drive (or vice versa). This makes them able to be used on building sites with no power supply. Both motors are extremely reliable and longlasting



Convenience: the adjustable height telescopic handle makes for convenient transport on the building site or in the in a vehicle

Construction-site-optimised tires: avoid punctures and allow easy and convenient transport – even on difficult sites



| TECHNICAL DATA | HEAVYCOAT 970 E | HEAVYCOAT 970 G | HEAVYCOAT 970 E SSP | HEAVYCOAT 970 G SSP |
|------------------------------|--|-----------------|---|---------------------|
| Voltage | 400 V / 50 Hz | - | 400 V / 50 Hz | - |
| Motor output | 5.5 kW | 6 kW | 5.5 kW | 6 kW |
| Operating pressure, max. | 250 bar. 25 MPa | 250 bar. 25 MPa | 250 bar. 25 MPa | 250 bar. 25 MPa |
| Delivery rate, max. | 10.3 l/min | 12 l/min | 10.3 l/min | 12 l/min |
| Nozzle size, max. | 0.056" | 0.056" | 0.056" | 0.056" |
| Recommended max. hose length | 100 m | 100 m | 100 m | 100 m |
| Viscosity, max. | 65.000 mPas | 65.000 mPas | 65.000 mPas | 50.000 mPas |
| Weight | 100 kg | 88 kg | 103 kg | 88 kg |
| Scope of delivery | Base unit HeavyCoat 970 E / G; HP hose DN13; Hose whip DN10; Connector 3/8" x 1/2"; Connector I = 1/4"NPSM x A = 3/8"NPSM; Airless gun AG 14 incl. TradeTip 3 nozzle holder; TradeTip 3 nozzle 443 | | Base unit HeavyCoat 970 E / G SSP; HP hose DN13; Hose whip DN10; Connector 3/8" x 1/2"; Airless gun AG 19 incl. TradeTip 3 nozzle holder; TradeTip 3 nozzle 443 | |
| Art. No. | 2332191 | 2332192 | 2332193 | 2332194 |

PRACTICAL ACCESSORIES FOR HYDRAULIC PISTON PUMPS

SUCTION SYSTEMS

Art. No.

| | |
|--|---------|
| Container suction system, incl. C-coupling adaptor | 349907 |
| Reduction adaptor B- to C-coupling | 9991651 |
| Blanking plug for C coupling | 97305 |
| Container Connector, for HeavyCoat, for direct suction of the material out of the large volume container | 2383128 |
| Large volume containers (100 l) | 2309956 |
| Large volume container, incl. sack support and roller press | 2309960 |
| Sack support incl. guide rail for roller, for large volume container | 2323178 |



Large volume container with Container Connector - For continuous work



EMULSION KIT (DN6) FOR ALL PUMPS WITH 1/2" CONNECTORS

Incl. suitable adapter and 2x adjustable wrench.
Suitable for PS 3.39, HC 750, HC 970, HC 950 SSP.

- Transition fitting (F) NPSM 1/2" to (M) NPSM 1/4"
- 2x HP hose DN6, NPSM 1/4", max. 27 MPa / 270 bar, 15 m
- Double connector 1/4" NPSM
- Vector Grip gun
- Nozzle extension, G-thread, 15 cm
- Nozzle extension, G-thread, 30 cm
- HEA ProTip nozzle 519
- TradeTip 3 nozzle 427
- TipClean 200 ml
- 2x adjustable wrench, 250 mm
- Gun filter, white, medium, 10 pieces

SPRAYKIT

Art. No.

Emulsion Kit (DN6)

2406208



FILLER KIT (DN10) FOR ALL PUMPS WITH 1/2" CONNECTIONS

Incl. suitable adapter and 2x adjustable wrench.
Suitable for PS 3.39, HC 750, HC 970, HC 950 SSP.

- Transition fitting (F) NPSM 1/2" to (M) NPSM 3/8"
- HP hose DN10, NPSM 3/8", max. 25 MPa / 250 bar, 15 m
- Double connector 3/8" NPSM to 1/4" NPSM
- Airless gun AG 14, G-thread 1/4"
- Nozzle extension, G-thread, 30 cm
- TradeTip 3 nozzle 335
- TradeTip 3 nozzle 439
- TipClean 200 ml
- 2x adjustable wrench, 250 mm
- Gun filter, white, medium, 10 pieces

SPRAYKIT

Art. No.

Filler Kit (DN10)

2406209



2GUN KIT – CONNECTION OF UP TO THREE GUNS ON ONE DEVICE

Suitable for: all Heavy Coat pumps, SF33 as well as PS 3.31 upwards.

- Adapter for multi-gun operation (for max. 3 guns)
- Vector Grip gun
- HP hose DN6, NPSM 1/4", 15 m, max. 27 MPa / 270 bar, 15 m
- Double connector NPSM 1/4"

SPRAYKIT

2Gun Kit

SPRAYKIT

2413598



SPIRAL PUMP

Simple operation – powerful and versatile

Do you appreciate the machine-based application of material, especially for harder tasks? Then a spiral pump from WAGNER is exactly the strong power packet you need for your construction sites. The robust, powerful performance of a spiral pump is delivered by a really simple rotor-stator function that WAGNER has been successfully using on the market for decades.



Robust, faithful reliable power packet for those difficult tasks:

Spiral pumps, also called eccentric spiral pumps, use displacement mechanisms to deliver the material. Two components, the rotor and the stator, are used for this. The rotor rotates and in doing so transports the material gently through the cavities of the stator. This simple function enables extremely heavy materials with different granulation and even fibres, such as render and other materials containing fillers, to be processed extremely efficiently.

The solution for heavy, textured material:

WAGNER spiral pumps can be used to achieve high-quality surfaces at a high working speed, for example with machine-assisted plaster application. Here the heavy, highly viscous material is moved with the help of the spiral pump through the hose to the spray gun, where it is atomized and applied smoothly. Comfortable and controlled, just like you're used to with WAGNER airless spray devices.

1. EASY TO OPERATE:

The simple, user-friendly operating concept for controlling the rotor and stator guarantees problem-free use, even for beginners.

2. FAST CLEANING:

WAGNER spiral pumps can be quickly disassembled for cleaning and maintenance and reassembled again thanks to the simple stator design, including directly on the construction site. This is made especially easy on the WAGNER PlastCoat 1030 by the automatic stator withdrawal. The material-carrying parts are also made from special materials which are easy to clean.

3. LONG SERVICE LIFE:

WAGNER spiral pumps are robust and easy to use. They are especially low-wear and low-maintenance, and are considerably quieter in operation than conventional piston pumps.

CROSS-SECTION OF THE SPIRAL PUMP

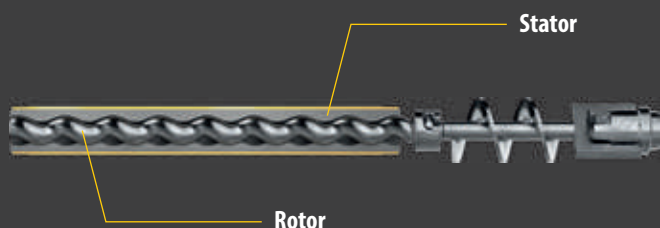

ADVANTAGES

- Simple and sturdy technology
- Gentle material transport
- Powerful processing of highly viscous materials
- Fully adjustable control of spray pressure
- Long lifespan
- Low maintenance

PLASTCOAT HP 30

Uniting the best – robust high-pressure spiral pump with airless technology for high-viscosity fillers

- **Simplest handling:** the user-friendly operating concept enables error-free application - even for beginners
- **Ergonomic airless gun and high pressure hose:** guarantee a high level of operating comfort during material application
- **Maximum performance:** the **PlastCoat HP 30** provides a convincing delivery capacity of >10kg/min. The spraying pressure can also be freely adjusted (40-120 bar)
- **Exceptionally reliable:** the low-wear and low-main-tenance spiral pump is characterised by its robust and proven technology

Plastic material hopper: easy to clean and with a capacity of 50 litres. Cover for the material hopper available separately as an accessory (Art. No. 2400 030)

Compact dimensions: with a height of 62 cm, the device can easily be filled with material

High-performance guns: with the airless gun AG 19, even high-viscosity materials can be processed without any problems

Easy control: thanks to the user friendly control panel



Colour-coded pressure gauge: allows perfect control of the pressure in coordination with the material being processed

Perfect for every construction site: the large, pneumatic tires ensure mobility on any construction site

HEA HIGH EFFICIENCY AIRLESS

Can easily be converted for emulsion work: with the emulsion kit comprising a 15 m hose (DN10) and the Vector Pro gun with HEA nozzle 517 (2400684)

Quiet and comfortable Airless spraying: without additional compressor with up to 120 bar working pressure

Also available as emulsion version. Art. No. 2400684



| TECHNICAL DATA | PLASTCOAT HP 30 |
|-------------------------------|--|
| Voltage | 230 V / 50 Hz |
| Motor output | 2.3 kW |
| Operating pressure, max. | 120 bar, 12 MPa |
| Delivery rate, max. | > 10 l/min |
| Nozzle size, max. | 0.055" |
| Recommended hose length, max. | 22.5 m |
| Weight | 72 kg |
| Scope of delivery | Base unit PC HP 30; HP hose Ø19; HP whip hose DN10; Airless gun AG 19 incl. TradeTip 3 nozzle holder; TradeTip 3 nozzle 443; PlastGuard longlasting pump protector |
| Art. No. | 2388301 |



PLASTCOAT 1030 E SPRAYPACK

The power to handle large volumes – compact and versatile

- **Compact and lightweight:** 58 kg of weight with a delivery height of 20 m and delivery radius of 40 m, materials up to a grain size of 6 mm supported
- **For large surfaces and easy transport:** integrated 50-litre plastic container, four wheels
- **Easy cleaning for use on building sites:** automatic stator extraction and automatic pressure release
- **Maintenance-free and robust:** brushless DC motor for a high torque
- **Closing the gun turns off the pump (electrically)**

Compact dimensions: with a height of 62 cm the unit can be easily filled using buckets or combined with a flow mixer

Automatic stator extraction: fast separation of pump and suction system, also great for quick assembly. Ideal for easy cleaning and transport

Plastic materialhopper: for an easy cleaning with a capacity of up to 50 litre

Included in scope of delivery: PC 1030 comes complete ready to spray incl. mortar hose (DN25, 10 m), automatic spraying lance with nozzle and toolbox.

Perfectly equipped for all construction sites: big, pneumatic tires ensures mobility on all construction sites

Ergonomic spraying lance: due to its modular construction and accessories (e.g. the lance extension) the spraying lance can adapt quickly to any project

| TECHNICAL DATA | PLASTCOAT 1030 E |
|-------------------------------|---|
| Voltage | 230 V / 50 Hz |
| Motor output | 2.2 kW |
| Operating pressure, max. | 40 bar, 4 MPa |
| Delivery rate, max. | 15 l/min |
| Grain size, max. | K6mm |
| Recommended hose length, max. | 40 m |
| Weight | 59 kg |
| Scope of delivery | Base unit PC HP 1030 E; Mortar hose DN25 incl. air hose and control cable; Spraying lance, automatic, incl. 6 mm nozzle; Pump lubricant, 500 ml |
| Art. No. | 2361588 |



PRACTICAL ACCESSORIES HP 30

| HOSES | Art. No. |
|--|----------|
| HP hose DN19, 10 m | 2390763 |
| HP Hose whip, DN10, 2.5 m | 2390762 |
| HP hose DN10, max. 25 MPa, NPSM 3/8", 15 m | 2336583 |

| SPRAY GUNS AND NOZZLES | Art. No. |
|---|----------|
| Airless gun AG 19, 25 MPa, G-thread 3/8", incl. TradeTip 3 nozzle holder | 2341127 |
| Airless gun Vector Pro, 1/4", incl. TradeTip3 nozzle holder, with 4-trigger | 538040 |
| TradeTip 3 nozzles | 553xxx |
| HEA ProTip nozzles | 554xxx |
| Nozzle holder, G-thread 7/8", for TradeTip 3 nozzles | 289390 |

| OTHER | Art. No. |
|--|----------|
| Nozzle extension, with holder, without nozzle, 25 cm | 2418854 |
| Nozzle extension, with holder, without nozzle, 50 cm | 2418855 |
| Cleaning ball DN16 | 2402355 |
| Cleaning ball DN19 | 342330 |
| Rotor and stator, complete, for PlastCoat HP 30 | 2395996 |
| Cover for material hopper | 2400030 |
| Press table | 2389048 |
| PlastGuard longlasting pump protector, 5 l | 2399960 |

PRACTICAL ACCESSORIES PC 1030

| MORTAR HOSES, INCL. AIR HOSE AND CONTROL CABLE | Art. No. |
|--|----------|
| Mortar hose DN19, V/M 27, 2 m incl. swivel joint | 2334131 |
| Mortar hose DN19, V/M 27, 10 m | 2325193 |
| Mortar hose DN25, V/M 27, 10 m | 2325197 |
| Mortar hose DN35, V/M 35, 13.3 m | 2325199 |

| NOZZLES | Art. No. |
|--|----------|
| Structure nozzle, stainless steel, 4 mm | 268779 |
| Structure nozzle, stainless steel, 6 mm | 268780 |
| Structure nozzle, stainless steel, 8 mm | 268781 |
| Structure nozzle, stainless steel, 10 mm | 268782 |
| Structure nozzle, stainless steel, 12 mm | 342327 |
| Structure nozzle, stainless steel, 15 mm | 342328 |

| ROTOR-STATOR KITS | Art. No. |
|---|----------|
| Rotor, D 6 - 2.5, 7.5 l/min delivery rate, max. | 348312 |
| Stator, D 6 - 2.5, 7.5 l/min delivery rate, max., black | 348311 |
| Rotor, D 6 - 3, 10 l/min delivery rate, max. | 348316 |
| Stator, D 6 - 3, 10 l/min delivery rate, max. 1, yellow | 348315 |
| Rotor, D 7 - 2, 15 l/min delivery rate, max. | 348926 |
| Stator, D 7 - 2, 15 l/min delivery rate, max., brown | 348925 |
| Rotor, D 8 - 1.5, 20 l/min delivery rate, max. | 2389048 |
| Stator, D 8 - 1.5, 20 l/min delivery rate, max., green | 2399960 |



PRESS TABLE

Our handy helper for the fast processing of bagged goods is available separately as an accessory (Art. No. 2389048).

TEMPSPRAY AIRLESS HEATED HOSE

Optimised for spraying highly viscous materials without dilution

Would you always like to ensure the ideal processing temperature and best viscosity of the material you are spraying, regardless of any seasonal fluctuations in temperature? The TempSpray heated hose from WAGNER is your guarantee for the best possible surface quality. The electric heating element, located directly in the flow of paint inside the hose system, heats the material evenly over the entire length of the hose to the pre-set temperature.



Heat up instead of diluting:

The ideal viscosity, along with the right working technique and equipment, are crucial for impressive results when spraying. If material is too thick, the result is an irregular spray pattern and a poor paint application. To make coating materials sprayable they usually have to be diluted. Heating the material with a TempSpray heated hose system from WAGNER has the same effect: viscosity is reduced, improving the application of the material. The result is a soft spray pattern and optimised atomisation quality.

Perfectly equipped for every area of application:

Heating the material in the heated hose improves the spraying properties of numerous coating materials - from stains and lacquers through to adhesives. The TempSpray systems can be fully controlled from 20° to 60°C. They can be used with all WAGNER airless devices, offering a broad range of applications.

1. LESS SOLVENT, VOC-COMPLIANT:

Heating the material reduces the amount of solvent needed since the material no longer needs to be diluted to achieve the required spray viscosity.

2. LOWER SPRAY PRESSURE:

Heating reduces the material's viscosity, allowing a lower spray pressure to be used. This reduces the overspray, protects the device being used and also protects the operator.

CHANGE IN VISCOSITY

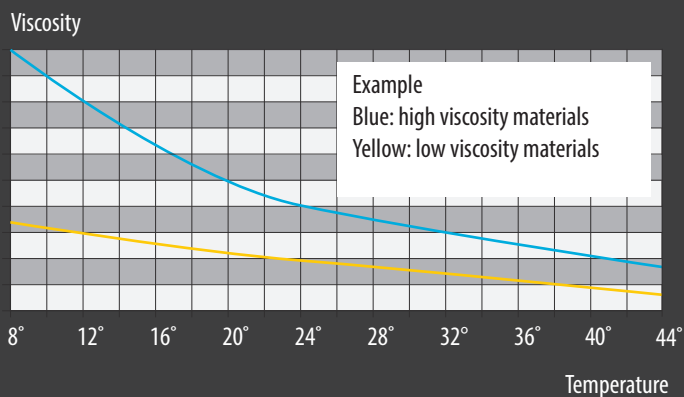

ADVANTAGES

- Easy to use
- Reduction of overspray
- Paint savings thanks to less overspray
- Increase in the thickness of the layers applied
- Less wear and tear on the device
- Constant paint temperature, even when outdoor temperatures are low
- Excellent edge coverage

TEMPSPRAY H 126 SPRAYPACK

The system that simplifies your work – perfect surface finishes through reduced viscosity with material heating

- **Easy to use:** specially designed for paint jobs, easily adapted for use with all Airless devices
- **Effortless operation:** flexible, steel-reinforced DN6 hose
- **Flexible:** continuous temperature regulation from 20° C - 60° C.
- **Lightweight:** weighs only 3.5 kg
- **Suitable for the following materials:** wood preservative, oils, stains, primers, undercoats, fillers, lacquers, 2K materials (Check the pot life).

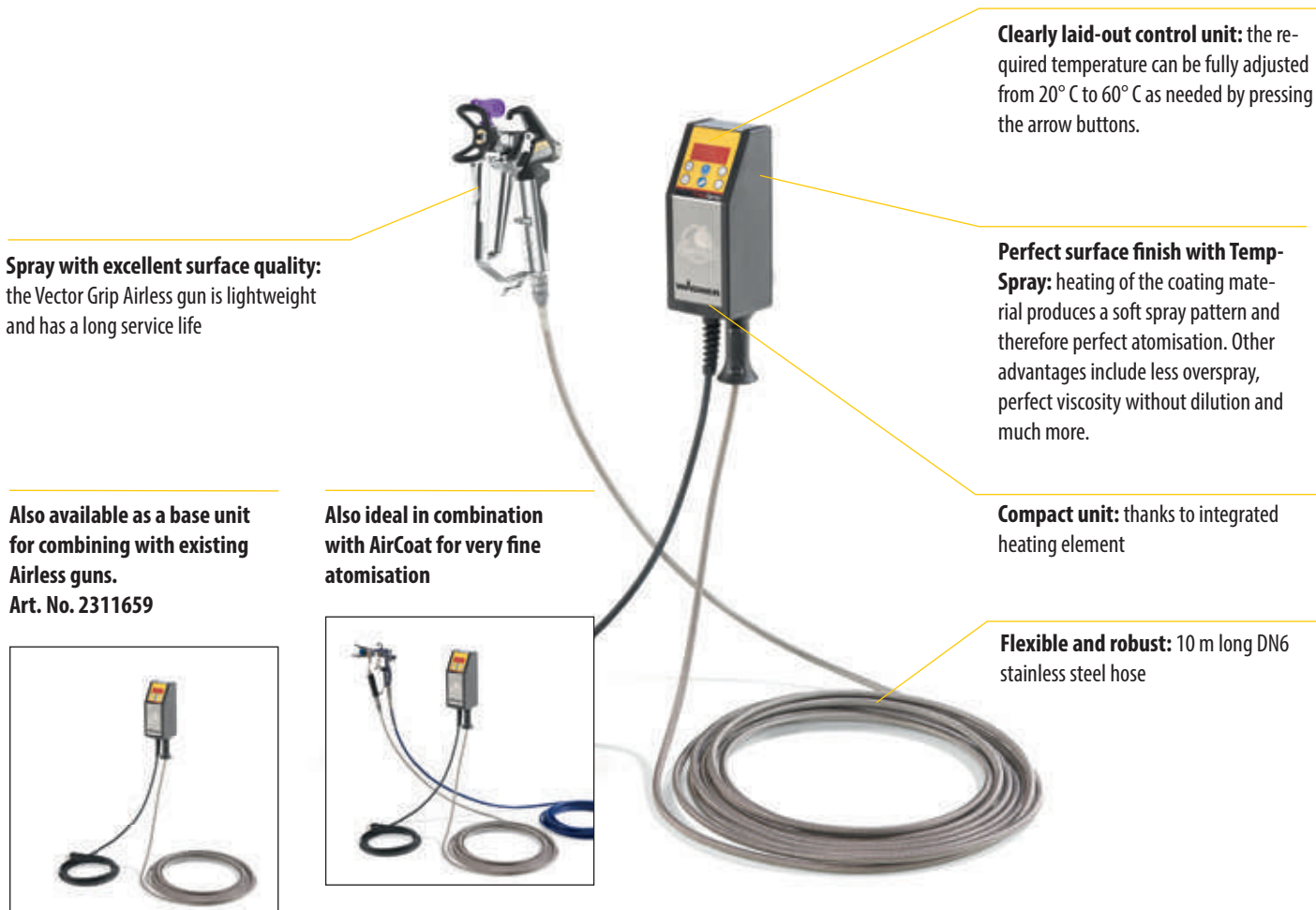

Spray with excellent surface quality: the Vector Grip Airless gun is lightweight and has a long service life

Clearly laid-out control unit: the required temperature can be fully adjusted from 20° C to 60° C as needed by pressing the arrow buttons.

Perfect surface finish with Temp-Spray: heating of the coating material produces a soft spray pattern and therefore perfect atomisation. Other advantages include less overspray, perfect viscosity without dilution and much more.

Also available as a base unit for combining with existing Airless guns.
Art. No. 2311659

Also ideal in combination with AirCoat for very fine atomisation

Compact unit: thanks to integrated heating element

Flexible and robust: 10 m long DN6 stainless steel hose



| TECHNICAL DATA | TEMPSPRAY H 126 |
|-------------------------------|---|
| Voltage | 230 V / 50 Hz |
| Heating power | 0.6 kW |
| Operating pressure, max. | 250 bar, 25 MPa |
| Temperature control | 20 - 60 °C |
| Recommended hose length, max. | 10 m |
| Viscosity, max. | 5.000 mPas |
| Power connection cable | 4 m |
| Scope of delivery | TempSpray H 126 basic unit 10 m; Airless gun Vector Grip incl. TradeTip 3 nozzle holder; TradeTip 3 FineFinish nozzle 410 |
| Art. No. | 2311852 |



TEMPSPRAY H 226 SPRAYPACK

Practical material heating system – for emulsions and latex paints

- **Specially designed for emulsions, latex paints**
- **Practical:** trolley-mounted hose reel for simple transportation on building sites
- **Flexible:** for indoor and outdoor use, easily adapted to all Airless units
- **Suitable for the following materials:** thick materials, high solids, emulsion paints, latex paints, exterior protection, roof coatings

Spray with excellent surface quality: the Airless Gun AG 14 is robust and has a long service life

Mobile: thanks to construction site-compatible reel drum

Also available as a base unit for combining with existing Airless guns
Art. No. 2311660



Clearly laid-out control unit: the required temperature can be fully adjusted from 20°C to 60°C as needed by pressing the arrow buttons

Perfect surface finish with Temp-Spray: heating of the coating material produces a soft spray pattern and therefore perfect atomisation. Other advantages include less overspray, perfect viscosity without dilution and much more

| TECHNICAL DATA | TEMPSPRAY H 226 |
|-------------------------------|---|
| Voltage | 230 V / 50 Hz |
| Heating power | 1.3 kW |
| Operating pressure, max. | 250 bar, 25 MPa |
| Temperature control | 20 - 60 °C |
| Recommended hose length, max. | 15 m |
| Viscosity, max. | 25.000 mPas |
| Power connection cable | 6 m |
| Scope of delivery | TempSpray H 226 base unit 15 m; Airless gun AG 14 incl. TradeTip 3 nozzle holder; HEA ProTip nozzle 517 |
| Art. No. | 2311853 |



TEMPSPRAY H 326 SPRAYPACK

The longest TempSpray of all time – for extended versatility and working radius

- **Ideal for emulsions, masonry, facade paints**
- **Twice the working radius for indoor and outdoor work:** 30 m heated hose
- **Practical:** large trolley-mounted hose reel for simple transportation on building sites
- **Suitable for the following materials:** thick materials, high solids, emulsion paints, latex paints, exterior

Spray with excellent surface quality: the Airless Gun AG 14 is robust and has a long service life

Mobile: thanks to construction site-compatible reel drum and extra-long hose (30 m)

Also available as a base unit for combining with existing Airless guns
Art. No. 2311661



























Clearly laid-out control unit: the required temperature can be fully adjusted from 20°C to 60°C as needed by pressing the arrow buttons

Perfect surface finish with TempSpray: heating of the coating material produces a soft spray pattern and therefore perfect atomisation. Other advantages include less overspray, perfect viscosity without dilution and much more

| TECHNICAL DATA | TEMPSPRAY H 326 |
|-------------------------------|---|
| Voltage | 230 V / 50 Hz |
| Heating power | 1.1 kW |
| Operating pressure, max. | 250 bar, 25 MPa |
| Temperature control | 20 - 60 °C |
| Recommended hose length, max. | 30 m |
| Viscosity, max. | 25.000 mPas |
| Power connection cable | 6 m |
| Scope of delivery | TempSpray H 326 base unit 30 m; Airless gun AG 14 incl. TradeTip 3 nozzle holder; HEA ProTip nozzle 521 |
| Art. No. | 2311854 |



| | FINISHCONTROL 3500 | FINISHCONTROL 5500 | FINECOAT 9700 | FINECOAT 9900 PLUS | SUPERFINISH 23 PRO HEA |
|---|---|---|---|---|---|
| Product image (may differ) |  |  |  |  |  |
| Spraying method |  |  |  |  |  |
| Technology |  |  |  |  |  |
| Drive |  |  |  |  |  |
| Voltage | 230 V / 50 Hz | 230 V / 50 Hz | 230 V / 50 Hz | 230 V / 50 Hz | 230 V / 50 Hz |
| Motor output | 0.7 kW | 1.15 kW | 1.15 kW | 1.5 kW | 1.3 kW |
| Operating pressure. max. | 0.2 bar, 0.02 MPa | 0.29 bar, 0.029 MPa | 0.3 bar, 0.03 MPa | 0.72 bar, 0.072 MPa | 250 bar, 25 MPa |
| Delivery rate. max. | - | - | - | - | 2.6 l/min |
| Nozzle size. max. | - | - | - | - | 0.023" |
| Recommended hose length. max. | - | - | - | - | 30 m |
| Viscosity. max. | - | - | - | - | 20.000 mPas |
| Weight | 2.3 kg | 6.6 kg | 6.8 kg | 15 kg | 27 kg |
| Art.-No. | 2341501 | 2422986 | 2426601 | 276048 | 2399198 |
| Suitable material |  |  |  |  |  |
| Suitable material - additional accessories are needed |  |  | | |  |
| Recommended intensity |  |  |  |  |  |

 Water and solvent-based paints, lacquers, oils, separating agents

 Fire protection, rust protection paints

 Structural waterproofing, bituminous coatings

 Injection

 Synthetic resin lacquers, PVC lacquers, 2K lacquers

 Emulsion and latex paints, adhesives, sealants

 Filler

 Primers, fillers

 Exterior paints, roof coatings, floor coatings, textured paint

 Plaster

| | SUPERFINISH 23 PLUS HEA | SUPERFINISH 23 PLUS AIRLESS ENAMEL | SUPERFINISH 23 PLUS TEMPSRAY | SUPERFINISH 23 PLUS AIRCOAT ENAMEL | SUPERFINISH 23 CR |
|---|----------------------------|--|---------------------------------|--|----------------------|
| Product image (may differ) | | | | | |
| Spraying method | | | | | Injection |
| Technology | | | | | |
| Drive | | | | | |
| Voltage | 230 V / 50 Hz | 230 V / 50 Hz | 230 V / 50 Hz | 230 V / 50 Hz | 230 V / 50 Hz |
| Motor output | 1.3 kW | 1.3 kW | 1.3 kW | 1.3 kW | 1.3 kW |
| Operating pressure, max. | 250 bar, 25 MPa | 250 bar, 25 MPa | 250 bar, 25 MPa | 250 bar, 25 MPa | 250 bar, 25 MPa |
| Delivery rate, max. | 2.6 l/min | 2.6 l/min | 2.6 l/min | 2.6 l/min | 2.6 l/min |
| Nozzle size, max. | 0.023" | 0.023" | 0.023" | 0.023" | - |
| Recommended hose length, max. | 30 m | 30 m | 10 m | 7.5 m | 15 m |
| Viscosity, max. | 20.000 mPas | 20.000 mPas | 20.000 mPas | 20.000 mPas | 20.000 mPas |
| Weight | 29 kg | 29 kg | 29 kg | 29 kg | 29 kg |
| Art. No. | 2384153 | 2341492 | 2341496 | 2353393 | 2415601 |
| Suitable material | | | | | |
| Suitable material - additional accessories are needed | | | | | |
| Recommended intensity | | | | | |

Small objects
up to 50 m²

Residential
50 m² - 200m²

Large residential
200 m² - 800m²

Commercial
more than 800m²

XVLP / HVLP

AirCoat

Airless

Plaster spraying

Piston pump

Diaphragm pump



































Turbine

Spiral pumps

Electric

Petrol-driven

TempSpray

| | SUPERFINISH 33 PRO | SUPERFINISH 33 PLUS | POWERPAINTER 90 EXTRA SKID VERSION | POWERPAINTER 90 EXTRA CART VERSION | PROSPRAY 3.20 HEA |
|---|---|---|---|---|---|
| Product image (may differ) |  |  |  |  |  |
| Spraying method |  |  |  |  |  |
| Technology |  |  |  |  |  |
| Drive |  |  |  |  |  |
| Voltage | 230 V / 50 Hz | 230 V / 50 Hz | 230 V / 50 Hz | 230 V / 50 Hz | 230 V / 50 Hz |
| Motor output | 2.2 kW | 2.2 kW | 0.8 kW | 0.8 kW | 1.0 kW |
| Operating pressure, max. | 250 bar, 25 MPa | 250 bar, 25 MPa | 200 bar, 20 MPa | 200 bar, 20 MPa | 207 bar, 20.7 MPa |
| Delivery rate, max. | 4.3 l/min | 4.3 l/min | 1.9 l/min | 1.9 l/min | 2 l/min |
| Nozzle size, max. | 0.033" | 0.033" | 0.019" | 0.019" | 0.021" |
| Recommended hose length, max. | 60 m | 60 m | 15 m | 15 m | 30 m |
| Viscosity, max. | 25.000 mPas | 25.000 mPas | - | - | 20.000 mPas |
| Weight | 43 kg | 50 kg | 10,2 kg | 25.2 kg | 13.6 kg |
| Art. No. | 2388260 | 2388259 | 2414079 | 2401275 | 2412438 |
| Suitable material |  |  |  |  |  |
| Suitable material - additional accessories are needed |  |  |  |  |  |
| Recommended intensity |  |  |  |  |  |



Water and solvent-based paints,
lacquers, oils, separating agents



Synthetic resin lacquers,
PVC lacquers, 2K lacquers



Primers, fillers



Fire protection,
rust protection paints



Emulsion and latex paints,
adhesives, sealants



Exterior paints, roof coatings,
floor coatings, textured paint



Structural waterproofing,
bituminous coatings



Filler



Plaster



Injection

| | PROSPRAY 3.21 HEA | PROSPRAY 3.25 | PROSPRAY 3.31 | PROSPRAY 3.39 EMULSION | PROSPRAY 3.39 FILLER |
|---|----------------------|-------------------|-------------------|------------------------------|----------------------------|
| Product image (may differ) | | | | | |
| Spraying method | | | | | |
| Technology | | | | | |
| Drive | | | | | |
| Voltage | 230 V / 50 Hz | 230 V / 50 Hz | 230 V / 50 Hz | 230 V / 50 Hz | 230 V / 50 Hz |
| Motor output | 1.035 kW | 1.1 kW | 1.84 kW | 2.19 kW | 2.19 kW |
| Operating pressure, max. | 221 bar, 22.1 MPa | 221 bar, 22.1 MPa | 221 bar, 22.1 MPa | 221 bar, 22.1 MPa | 221 bar, 22.1 MPa |
| Delivery rate, max. | 2 l/min | 2.6 l/min | 3.8 l/min | 5 l/min | 5 l/min |
| Nozzle size, max. | 0.023" | 0.027" | 0.032" | 0.039" | 0.039" |
| Recommended hose length, max. | 30 m | 30 m | 60 m | 60 m | 60 m |
| Viscosity, max. | 20.000 mPas | 25.000 mPas | 25.000 mPas | 30.000 mPas | 30.000 mPas |
| Weight | 17.9 kg | 27.4 kg | 43.5 kg | 50 kg | 50 kg |
| Art. No. | 532089 | 2308260 | 2308262 | 2351261 | 2308264 |
| Suitable material | | | | | |
| Suitable material - additional accessories are needed | | | | | |
| Recommended intensity | | | | | |

Small objects
up to 50 m²

Residential
50 m² - 200m²

Large residential
200 m² - 800m²

Commercial
more than 800m²

XVLP / HVLP

AirCoat

Airless

Plaster spraying

Piston pump

Diaphragm pump































Turbine

Spiral pumps

Electric

Petrol-driven

TempSpray

| | HEAVYCOAT 750 E / E SSP | HEAVYCOAT 750 G | HEAVYCOAT 950 E / E SSP | HEAVYCOAT 950 G | HEAVYCOAT 970 E / E SSP |
|----------------------------------|---|---|---|---|---|
| Product image (may differ) |  |  |  |  |  |
| Spraying method |  |  |  |  |  |
| Technology |  |  |  |  |  |
| Drive |  |  |  |  |  |
| Voltage | 230 V / 50 Hz | 230 V / 50 Hz | 230 V / 50 Hz | 230 V / 50 Hz | 400 V / 50 Hz |
| Motor output | 3.1 kW | 4.1 kW | 3.6 kW | 4.1 kW | 5.5 kW |
| Operating pressure, max. | 250 bar, 25 MPa | 250 bar, 25 MPa | 250 bar, 25 MPa | 250 bar, 25 MPa | 250 bar, 25 MPa |
| Delivery rate, max. | 6 l/min | 7.6 l/min | 6.6 l/min | 8 l/min | 10.3 l/min |
| Nozzle size, max. | 0.043" | 0.041" | 0.052" | 0.052" | 0.056" |
| Grain size, max. | - | - | - | - | - |
| Recommended hose length, max. | 100 m | 100 m | 100 m | 100 m | 100 m |
| Viscosity, max. | 50.000 mPas | 65.000 mPas | 50.000 mPas | 50.000 mPas | 65.000 mPas |
| Weight | 85 kg / 87 kg | 81 kg | 83 kg / 84.5 kg | 76 kg | 100 kg / 103 kg |
| Art. No. | 2371027 / 2371028 | 2371029 | 2332184 / 2332187 | 2332186 | 2332191 / 2332193 |
| Suitable material |  |  |  |  |  |
| Recommended intensity |  |  |  |  |  |

 Water and solvent-based paints, lacquers, oils, separating agents

 Fire protection, rust protection paints

 Structural waterproofing, bituminous coatings

 Injection

 Synthetic resin lacquers, PVC lacquers, 2K lacquers

 Emulsion and latex paints, adhesives, sealants

 Filler

 Primers, fillers

 Exterior paints, roof coatings, floor coatings, textured paint

 Plaster

| | HEAVYCOAT 970 G / G SSP | PLASTCOAT HP 30 | PLASTCOAT 1030 E |
|----------------------------------|---|---|---|
| Product image (may differ) |  |  |  |
| Spraying method |  |  |  |
| Technology |  |  |  |
| Drive |  |  |  |
| Voltage | 400 V / 50 Hz | 230 V / 50 Hz | 230 V / 50 Hz |
| Motor output | 6 kW | 2.3 kW | 2.2 kW |
| Operating pressure, max. | 250 bar, 25 MPa | 120 bar, 12 MPa | 40 bar, 4 MPa |
| Delivery rate, max. | 12 l/min | > 10 kg/min | 15 l/min |
| Nozzle size, max. | 0.056" | 0.055" | - |
| Grain size, max. | - | - | K6 mm |
| Recommended hose length, max. | 100 m | 22.5 m | 40 m |
| Viscosity, max. | 65.000 mPas | - | - |
| Weight | 88 kg | 72 kg | 59 kg |
| Art. No. | 2332192 / 2332194 | 2388301 | 2361588 |
| Suitable material |  |  |  |
| Recommended intensity |  |  |  |

 Small objects
up to 50 m²

 Residential
50 m² - 200m²

 Large residential
200 m² - 800m²

 Commercial
more than 800m²

 XVLP / HVLP

 AirCoat

 Airless

 Plaster spraying

 Piston pump

 Diaphragm pump

 Turbine

 Spiral pumps

 Electric

 Petrol-driven

 TempSpray

| | TEMPSPRAY H 126 BASE UNIT | TEMPSPRAY H 126 SPRAYPACK |
|----------------------------------|------------------------------|------------------------------|
| Product image (may differ) | | |
| Spraying method | - | |
| Technology | | |
| Drive | | |
| Voltage | 230 V / 50 Hz | 230 V / 50 Hz |
| Heating power | 0.6 kW | 0.6 kW |
| Operating pressure, max. | 250 bar, 25 MPa | 250 bar, 25 MPa |
| Temperature control | 20 - 60 °C | 20 - 60 °C |
| Recommended hose length, max. | 10 m | 10 m |
| Viscosity, max. | 5.000 mPas | 5.000 mPas |
| Weight | 3.2 kg | - |
| Power connection cable | 4 m | 4 m |
| Art. No. | 2311659 | 2311852 |

 Water and solvent-based paints,
lacquers, oils, separating agents

 Fire protection,
rust protection paints

 Structural waterproofing,
bituminous coatings

 Injection

 Synthetic resin lacquers,
PVC lacquers, 2K lacquers















 Emulsion and latex paints,
adhesives, sealants

 Filler

 Primers, fillers

 Exterior paints, roof coatings,
floor coatings, textured paint

 Plaster

| | TEMPSPRAY H 226 BASE UNIT | TEMPSPRAY H 226 SPRAYPACK | TEMPSPRAY H 326 BASE UNIT | TEMPSPRAY H 326 SPRAYPACK |
|----------------------------------|---|---|---|---|
| Product image (may differ) |  |  |  |  |
| Spraying method | - |  | - |  |
| Technology |  |  |  |  |
| Drive |  |  |  |  |
| Voltage | 230 V / 50 Hz | 230 V / 50 Hz | 230 V / 50 Hz | 230 V / 50 Hz |
| Heating power | 1.3 kW | 1.3 kW | 1.1 kW | 1.1 kW |
| Operating pressure, max. | 250 bar, 25 MPa | 250 bar, 25 MPa | 250 bar, 25 MPa | 250 bar, 25 MPa |
| Temperature control | 20 - 60 °C | 20 - 60 °C | 20 - 60 °C | 20 - 60 °C |
| Recommended hose length, max. | 15 m | 15 m | 30 m | 30 m |
| Viscosity, max. | 25.000 mPas | 25.000 mPas | 25.000 mPas | 25.000 mPas |
| Weight | 18 kg | - | 23 kg | - |
| Power connection cable | 6 m | 6 m | 6 m | 6 m |
| Art. No. | 2311660 | 2311853 | 2311661 | 2311854 |

 Small objects
up to 50 m²

 Residential
50 m² - 200m²

 Large residential
200 m² - 800m²

 Commercial
more than 800m²

 XVLP / HVLP

 AirCoat

 Airless

 Plaster spraying

 Piston pump

 Diaphragm pump

 Turbine

 Spiral pumps

 Electric

 Petrol-driven

 TempSpray

WAGNER ACCESSORIES

Perfectly equipped for every application

WAGNER offers innovative accessories which offer extended possibilities for the use of your system. These include the practical interior-fed paint roller for effective processing of emulsions indoors and outdoors as well as a wide range of accessories to make your daily work easier. On the following pages you will find a selection of our accessories.

THE FULL RANGE OF ACCESSORIES

You can find an overview of the entire range of accessories online at www.wagner-group.com or in our separate accessories brochure. Our service staff or specialist dealers will be happy to answer any specific questions you may have.



AILRESS SPRAYKITS

Perfectly tailored to every application

WAGNER SprayKits are specially adjusted accessory packages that expand the application range of your spraying unit.

ENAMEL KIT (DN4) FOR ALL SUPERFINISH PUMPS

Suitable for SF 23 Plus, SF 33, SF 27, SF 31.

- HP hose DN4, NPSM 1/4", max. 27 MPa / 270 bar, 7.5 m
- Vector Pro gun
- Nozzle extension, G-thread, 15 cm
- FineFinish TT3 nozzle 308 (enamel)
- FineFinish TT3 nozzle 412 (filler)
- TipClean 200 ml
- Gun filter, red, extra fine, 10 pieces
- Hopper 5 litre, M36 x 2

| SPRAYKIT | Art. No. |
|------------------|----------|
| Enamel Kit (DN4) | 2406207 |



ENAMEL KIT (DN4) FOR PROSPRAY PUMPS

Suitable for PS 20, PS 3.20, PS 3.21, PS 3.25 on skid.

- HP hose DN4, NPSM 1/4", 7.5 m, max. 27 MPa / 270 bar
- Vector Pro gun
- Nozzle extension, G-thread, 15 cm
- FineFinish TT3 nozzle 308 (enamel)
- FineFinish TT3 nozzle 412 (filler)
- TipClean 200 ml
- Gun filter, red, extra fine, 10 pieces
- Hopper 5 litre, for ProSpray
- Hopper filter package

| SPRAYKIT | Art. No. |
|------------------|----------|
| Enamel Kit (DN4) | 2406206 |



HEA KIT (DN6) FOR ALL PUMPS WITH 1/4" CONNECTORS

Suitable for all SuperFinish and ProSpray pumps, as well as PowerPainter 90

- HP hose DN6, NPSM 1/4", max. 27 MPa / 270 bar, 15 m
- Vector Pro gun
- Nozzle extension; G-thread; 15 cm
- HEA ProTip nozzle 517
- HEA ProTip nozzle 311
- TipClean 200 ml
- Gun filter, white, medium, 10 pieces



SPRAYKIT

Art. No.

HEA Kit (DN6)

2408212

EMULSION KIT (DN6) FOR ALL PUMPS WITH 1/2" CONNECTORS

Incl. suitable adapter and 2x adjustable wrench.

Suitable for PS 3.39, HC 750, HC 970, HC 950 SSP.

- Transition fitting (F) NPSM 1/2" to (M) NPSM 1/4"
- 2x HP hose DN6, NPSM 1/4", max .27 MPa / 270 bar, 15 m
- Double connector 1/4" NPSM
- Vector Grip gun
- Nozzle extension, G-thread, 15 cm
- Nozzle extension, G-thread, 30 cm
- HEA ProTip nozzle 519
- TradeTip 3 nozzle 427
- TipClean 200 ml
- 2x adjustable wrench, 250 mm
- Gun filter, white, medium, 10 pieces



SPRAYKIT

Art. No.

Emulsion Kit (DN6)

2406208

EMULSION KIT (DN10) FOR PLASTCOAT HP 30

With HEA technology, PC HP 30 can also be used to apply emulsion paints with the best surface quality.

- HP hose DN10, max. 25 MPa / 250 bar, NPSM 3/8", 15 m
- Vector Pro gun
- HEA ProTip nozzle 517
- Adapter FM 1/2BSPP-3/8NPSM
- Adapter FM 1/4 NPSM-3/8NPSM

SPRAYKIT

Art. No.

Emulsion Kit (DN10)

2400684



FILLER KIT (DN10) FOR ALL PUMPS WITH 1/2" CONNECTIONS

Incl. suitable adapter and 2x adjustable wrench.
Suitable for PS 3.39, HC 750, HC 970, HC 950 SSP.

- Transition fitting (F) NPSM 1/2" to (M) NPSM 3/8"
- HP hose DN10, NPSM 3/8", max. 25 MPa / 250 bar, 15 m
- Double connector 3/8" NPSM to 1/4" NPSM
- Airless gun AG 14, G-thread 1/4"
- Nozzle extension, G-thread, 30 cm
- TradeTip 3 nozzle 335
- TradeTip 3 nozzle 439
- TipClean 200 ml
- 2x adjustable wrench, 250 mm
- Gun filter, white, medium, 10 pieces

SPRAYKIT

Art. No.

Filler Kit (DN10)

2406209



2GUN KIT - CONNECTION OF UP TO THREE GUNS ON ONE DEVICE

Suitable for: all Heavy Coat pumps, SF33 as well as PS 3.31 upwards.

- Adapter for multi-gun operation (for max. 3 guns)
- Vector Grip gun
- HP hose DN6, NPSM 1/4", 15 m, max. 27 MPa / 270 bar, 15 m
- Double connector NPSM 1/4"

SPRAYKIT

Art. No.

2Gun Kit

2413598











ACCESSORIES – AIRLESS NOZZLES

The heart of the spraying process

Across all technologies – Airless, AirCoat, plaster spraying with worm pumps, HVLP or XVLP – nozzles and air caps play a decisive role in surface quality. In addition to the actual pump, they are the true heart of the spraying process. This is where the material is atomised and where the fineness of the droplet formation in the spray pattern is determined. The nozzle size also determines the quantity of material forced through the bore. Top-quality nozzles are a prerequisite for premium surface finishes in line with your professional standards.



| | | | | | |
|--|---|---|---|---|--|
|  | Water and solvent-based lacquers, lacquer paints, oils, separating agents |  | Synthetic resin lacquers, PVC lacquers, 2K lacquers |  | Primers, fillers |
|  | Fire protection, rust protection paints |  | Emulsion and latex paints, adhesives, sealants |  | Exterior paints, roof coatings, floor coatings, textured paint |
|  | Structural waterproofing, bituminous coatings |  | Filler |  | Plaster |



Art. No.
553xxx

AIRLESS TRADETIP 3 NOZZLES – PERFECT AND DURABLE

The yellow standard nozzle offers a wide range of applications for processing primers, lacquers, glazes, emulsion paints, fire and rust protection paints up to airless filler.

| | | Orifice size (inch) | | | | | | | | | | | | | | | | | | | | | | | | |
|-----------------|---------------------|---------------------|-------|-------|--------|-------|-------|-------|-------|-------|-------|-------|-------|-------|-------|-------|-------|-------|-------|-------|-------|-------|-------|-------|-------|-------|
| | | 0.007 | 0.009 | 0.011 | 0.013 | 0.015 | 0.017 | 0.019 | 0.021 | 0.023 | 0.025 | 0.027 | 0.029 | 0.031 | 0.033 | 0.035 | 0.039 | 0.043 | 0.045 | 0.051 | 0.052 | 0.055 | 0.061 | 0.063 | 0.065 | 0.067 |
| Jet width (mm)* | 100 | 107 | 109 | 111 | 113 | 115 | 117 | | | | | | | | | | | | | | | | | | | |
| | 120 | 207 | 209 | 211 | 213 | 215 | 217 | 219 | 221 | 223 | 225 | 227 | 229 | 231 | 233 | 235 | | 243 | | | 252 | | 261 | 263 | | 267 |
| | 150 | 307 | 309 | 311 | 313 | 315 | 317 | 319 | 321 | 323 | 325 | 327 | 329 | 331 | 333 | 335 | | | | | | | | | | |
| | 190 | 407 | 409 | 411 | 413 | 415 | 417 | 419 | 421 | 423 | 425 | 427 | 429 | 431 | 433 | 435 | 439 | 443 | 445 | 451 | | 455 | 461 | 463 | | 467 |
| | 225 | | 509 | 511 | 513 | 515 | 517 | 519 | 521 | 523 | 525 | 527 | 529 | 531 | 533 | 535 | 539 | 543 | 545 | 551 | | 555 | 561 | | 565 | |
| | 270 | | 609 | 611 | 613 | 615 | 617 | 619 | 621 | 623 | 625 | 627 | 629 | 631 | 633 | 635 | 639 | 643 | | 651 | | 655 | 661 | | 665 | |
| | 300 | | | | | 715 | 717 | 719 | 721 | 723 | 725 | | | 731 | | 735 | | | | | | | | | | |
| | 330 | | | | 813 | 815 | 817 | 819 | 821 | 823 | 825 | 827 | | 831 | | | | | | | | | | | | |
| | 385 | | | | | | | 919 | | | | | | | | | | | | | | | | | | |
| | Flow rate (l/min)** | | 0.19 | 0.34 | 0.45 | 0.68 | 0.91 | 1.17 | 1.47 | 1.78 | 2.15 | 2.53 | 2.95 | 3.44 | 3.89 | 4.42 | 4.99 | 6.20 | 7.52 | 8.24 | 10.58 | | | | | |
| Filter | | red | | | yellow | | | white | | | | | | | | | green | | | | | | | | | |



Art. No.
554xxx

HEA PROTIP NOZZLES – UP TO 55 % LESS OVERSPRAY

The new WAGNER HEA ProTip airless nozzle provides a perfect surface finish at reduced spraying pressure. Compared to standard airless technology the spray pattern is gently feathered and free from edge strips.

| | | Orifice size (inch) | | | | | | | |
|---------------------|-----|---------------------|-------|--------|-------|-------|-------|----|------------------|
| | | 0.011 | 0.013 | 0.015 | 0.017 | 0.019 | 0.021 | | |
| Jet width (mm)* | 120 | 211 | 213 | | | | | 20 | Spray angle in ° |
| | 150 | 311 | 313 | | | | | 30 | |
| | 190 | 411 | 413 | 415 | 417 | | 421 | 40 | |
| | 225 | | | 515 | 517 | 519 | 521 | 50 | |
| | 270 | | | 615 | 617 | 619 | 621 | 60 | |
| Flow rate (l/min)** | | 0.45 | 0.68 | 0.91 | 1.17 | 1.47 | 1.78 | | |
| Filter | | red | | yellow | white | | | | |



Art. No.
554xxx

AIRLESS TRADETIP 3 FINEFINISH NOZZLES

Top paint nozzle with optimised third-generation properties. With double special core for ultra-fine droplet formation and exceptionally high-quality surfaces, even in low pressure ranges. FineFinish nozzles are coloured purple.

| | | Orifice size (inch) | | | | | |
|---------------------|-----|---------------------|-------|-------|-------|----|------------------|
| | | 0.008 | 0.010 | 0.012 | 0.014 | | |
| Jet width (mm)* | 120 | 208 | 210 | 212 | 214 | 20 | Spray angle in ° |
| | 150 | 308 | 310 | 312 | 314 | 30 | |
| | 190 | 408 | 410 | 412 | 414 | 40 | |
| | 225 | | 510 | 512 | 514 | 50 | |
| Flow rate (l/min)** | | 0.26 | 0.42 | 0.6 | 0.79 | | |
| Filter | | red | | | | | |

* Spray width (mm) at approx. 30 cm distance from the object and 100 bar pressure, with synthetic resin paint, 20 DIN seconds

** Measured with water at 120 bar pressure



Art. No. 1009xxx

AIRLESS NESPRI TWINTIP NOZZLES

For mist-free spraying: NESPRI TwinTip nozzles have two nozzle orifices one directly above the other – For a perfect spray pattern with high material throughput even in low pressure ranges. Guaranteed mist-free thanks to the use of the NESPRI spray device in combination with the NESPRI TwinTip and NESPRI paints from Caparol. Different sizes are available to adapt ideally to the relevant environment.

| Jet width (mm)* | Orifice size (inch) | | | | Spray angle in° |
|-----------------|---------------------|-------|-------|-------|--------------------|
| | 0.013 | 0.021 | 0.023 | 0.027 | |
| 100 | | 215 | | | 20 |
| 110 | 213 *** | | | | 20 |
| 130 | | 316 | 317 | 319 | 30 |
| Filter | white | | | | |

*** Mono nozzle for trimming jobs



Art. No. 90xxx

AIRLESS STANDARD FAN NOZZLES

Airless standard flat jet nozzle are especially suitable for painting applications, but can be used also for high viscosity materials. They are ideal for the fast processing of large quantities of material. The high-quality nozzles are robust and suitable for all common Airless guns.

| Jet width (mm)* | Orifice size (inch) | | | | | | | | | | | | | | | | | |
|---------------------|---------------------|-------|------------|-------|--------|-------|--------------|-------|-------|-------|-------|-------|-------|-------|-------|-------|-------|--|
| | 0.007 | 0.009 | 0.011 | 0.013 | 0.015 | 0.017 | 0.019 | 0.021 | 0.023 | 0.025 | 0.027 | 0.030 | 0.031 | 0.035 | 0.039 | 0.043 | 0.051 | |
| 90 | | | 111 | | 115 | | | | | | | | | | | | | |
| 100 | | | 211 | 113 | 215 | | | | | | | | | | | | | |
| 120 | | | 311 | 213 | | 217 | | | 223 | 225 | | | | 235 | | | | |
| 150 | | 209 | | 313 | | 317 | 219 | 221 | | | 227 | | | | | 243 | | |
| 160 | 407 | 309 | | | 315 | | 319 | | | | | | | | | | | |
| 190 | 507 | 409 | | | | 417 | 419 | 421 | 423 | 425 | | | | | | | | |
| 215 | | 509 | 411 | 413 | 415 | | | | | | | | 431 | | | | | |
| 225 | | 609 | 511 | | | 517 | | | | | 427 | | 531 | 435 | | | | |
| 250 | | | | | 515 | | | 521 | 523 | 525 | 527 | | | | | | | |
| 270 | | | 611 | 513 | 615 | | 519 | | | 625 | 627 | | 631 | 535 | | 543 | 552 | |
| 300 | | | | 613 | 715 | 617 | 619 | | 623 | | | 629 | | 635 | | | | |
| 330 | | | | | | 717 | 719 | 621 | 723 | | 827 | | | | | | | |
| 385 | | | | 813 | 815 | | | 821 | 823 | 825 | | | | | | | | |
| 400 | | | | | | | 819 | | | | | | | | | | | |
| 480 | | | | | | | | | | | | | | | 839 | | | |
| Flow rate (l/min)** | 0.19 | 0.34 | 0.49 | 0.68 | 0.91 | 1.17 | 1.47 | 1.78 | 2.15 | 2.53 | 2.95 | 3.44 | 3.89 | 4.99 | 6.2 | 7.52 | 11.0 | |
| Filter | red | | red/yellow | | yellow | | yellow/white | | white | | | green | | | | | | |

* Spray width (mm) at approx. 30 cm distance from the object and 100 bar pressure, with synthetic resin paint, 20 DIN seconds
** Measured with water at 120 bar pressure

 Water and solvent-based lacquers, lacquer paints, oils, separating agents

 Fire protection, rust protection paints

 Structural waterproofing, bituminous coatings

 Synthetic resin lacquers, PVC lacquers, 2K lacquers

 Emulsion and latex paints, adhesives, sealants

 Filler

 Primers, fillers

 Exterior paints, roof coatings, floor coatings, textured paint

 Plaster

ACCESSORIES – AIRLESS

| AIRLESS GUN VECTOR INFINITY | Art. No. |
|--|----------|
| Vector Infinity with G-thread 1/4", incl. TradeTip 3 nozzle holder, 34.5 MPa (345 bar) with 2-finger trigger and adaptable hand grip | 538085 |
| Small grip, for customization to any hand, for Vector Infinity | 538264 |
| Medium grip, for customization to any hand, for Vector Infinity | 538265 |
| Large grip, for customization to any hand, for Vector Infinity | 538266 |



Vector Infinity is - the premium gun



Vector Grip - fits perfectly in the hand and is suitable for heated applications

| AIRLESS GUN VECTOR GRIP | Art. No. |
|---|----------|
| Vector Grip with G-thread 1/4", incl. TradeTip 3 nozzle holder, 25 MPa (250 bar) with 2- and 4-finger trigger and medium-sized grip | 538043 |
| Small grip, for customization to any hand, for Vector Grip | 538228 |
| Medium grip, for customization to any hand, for Vector Grip | 538229 |
| Large grip, for customization to any hand, for Vector Grip | 538230 |

| AIRLESS GUN VECTOR PRO | Art. No. |
|---|----------|
| Vector Pro with G-thread 1/4", incl. TradeTip 3 nozzle holder, 25 MPa (250 bar) with 4-finger trigger | 538040 |
| Vector Pro with G-thread 1/4", incl. TradeTip 3 nozzle holder, 25 MPa (250 bar) with 2-finger trigger | 538041 |

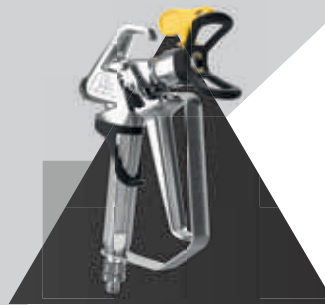

Vector Pro - the entry level spray gun

| AIRLESS GUN AG 14 WITH 4-FINGER TRIGGER | Art. No. |
|--|----------|
| Airless gun AG 14, G-thread 1/4", 27 MPa (270 bar), incl. TradeTip 3 nozzle holder | 0502081A |

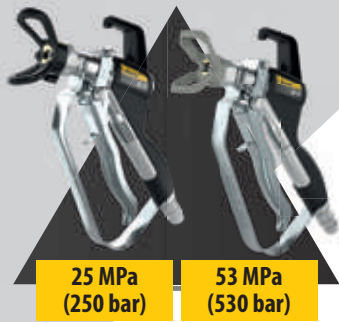

AG 19 - is particularly suitable for highly viscous materials

| FILLER AIRLESS GUN AG 19 WITH 4-FINGER TRIGGER | Art. No. |
|--|----------|
| Airless gun AG 19, 25 MPa, G-thread 3/8", incl. TradeTip 3 nozzle holder | 2341127 |

| HIGH-PRESSURE AIRLESS GUN AG 19 WITH 4-FINGER TRIGGER | Art. No. |
|--|----------|
| Airless gun AG 19 with G-thread 1/4", 53 MPa (530 bar) | 2343778 |

HIGH-PRESSURE HOSES**Art. No.**

| | |
|---------------------------|----------|
| DN3, M16 x 1.5, 7.5m | 9984584 |
| DN3, NPS (M) 1/4", 7.5 m | 9984583 |
| DN3, NPS (M) 1/4", 10 m | 2301052 |
| DN4, M16 x 1.5, 7.5 m | 9984510 |
| DN4, NPS (M) 1/4", 7.5 m | 9984573 |
| DN4, NPS (M) 1/4", 10 m | 2302374 |
| DN6, M16 x 1.5, 15 m | 9984507 |
| DN6, M16 x 1.5, 30 m | 9984562 |
| DN6, NPS (M) 1/4", 15 m | 9984574 |
| DN6, NPS (M) 1/4", 30 m | 9984575 |
| DN10, PS (M) 3/8", 15 m | 2336583* |
| DN10, PS (M) 3/8", 30 m | 2336584* |
| DN13, NPS (M) 1/2", 15 m | 2336585* |
| DN 19, NPS (M) 3/4", 15 m | 2336586* |

* Max. 25 MPa (250 bar)

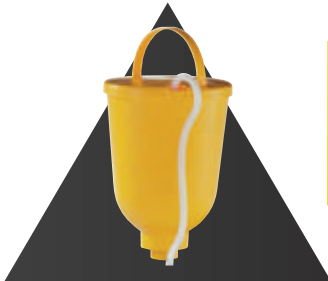

5 litre hopper – perfect for small volumes of paint

SUCTION SYSTEMS**Art. No.**

| | |
|--|---------|
| Container suction system, incl. C-coupling adaptor | 349907 |
| Reduction adaptor B- to C-coupling | 9991651 |
| Blanking plug for C coupling | 97305 |
| Container Connector, for HeavyCoat, for direct suction of the material out of the large volume container | 2383128 |
| Container Connector, for SF 27/31/33 | 2371930 |
| Large volume containers (100 l) | 2309956 |
| Large volume container, incl. sack support and roller press | 2309960 |
| Sack support incl. guide rail for roller, for large volume container | 2323178 |
| PumpRunner (only for rigid suction system) | 2306987 |
| Suction system, for SF 23 Plus, incl. PumpRunner | 2342879 |

OTHER**Art. No.**

| | |
|--|---------|
| Hose reel HR30, M16x1.5, for 30 m HP hose, usable for SF23 Plus / SF 27 / SF 31 (without hose) | 341910 |
| Hose reel HR30, 1/4" NPS, for 30 m HP hose, usable for SF 33 (without hose) | 2392523 |
| Hose reel HR45, incl. 30 m HP hose DN6, for all diaphragm and piston pumps | 341912 |
| Hose whip DN10, max. 25 MPa, NPSM 3/8", 2.5 m | 2336582 |

High-pressure hoses are available in different lengths and inside diameters. The perfect hose for every application

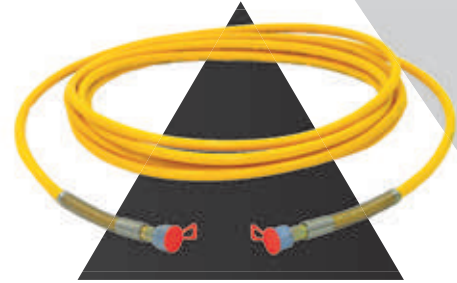
**HOPPER****Art. No.**

| | |
|---|---------|
| Hopper 20 litre, M36x2, for SuperFinish | 341266 |
| Hopper 5 litre, M36x2, for SuperFinish | 341265 |
| Hopper 5 litre, with TopClean, for SuperFinish | 341268 |
| Hopper, 5 litre, for PowerPainter 90 Extra | 2423122 |
| Hopper, 5 litre, for ProSpray 3.20, 20, 3.21, 3.25 Skid | 704-453 |

PumpRunner – for clean and easy transportation of the pump



Hose reel – perfect hose management for optimum handling



PAINT ROLLERS**Art. No.**

| | |
|--|---------|
| Inline Roller IR 100 incl. HP hose DN4, max. 27 MPa, 7.5m, extension 0.5m, woven plush paint roller, short pile 13 mm and much more. | 345010 |
| Inner-Feed Roller, 23 cm | 2418370 |
| Inner-Feed Roller, incl. extension (0.9 m) | 2420499 |
| SprayRoller Frame, 25 cm | 2411697 |
| SprayRoller Frame, incl. extension (0.9 m) | 2420497 |
| SprayRoller Frame, 23 cm | 2418371 |
| SprayRoller Cage, incl. extension (0.9 m) | 2420496 |
| Nozzle extension (0.9 m) | 2420538 |

Airless paint roller – consistent coating with paint roller

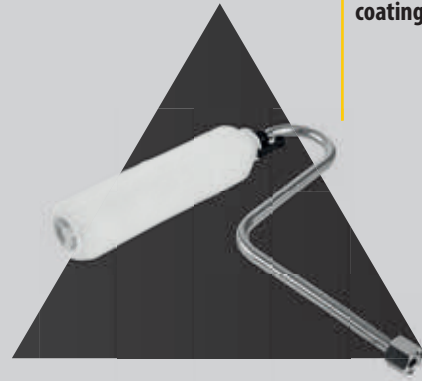

SpeedShield – Trimming cutting in without masking. Delivered without nozzle and extension

**SONSTIGES****Art. No.**

| | |
|---|---------|
| Pressure gauge combination cpl. HEA (MPa) | 2383995 |
| Distributor adapter for max. 3 guns | 2304430 |
| Hose connector A 1/4" NPSM - A 1/4" NPSM | 34038 |
| Connector I 1/4" NPSM - A 3/8" NPSM | 179732 |
| SpeedShield | 538905 |

NOZZLE EXTENSIONS**Art. No.**

| | |
|--|---------|
| Nozzle extension, with holder, without nozzle, 12.5 cm | 2418853 |
| Nozzle extension, with holder, without nozzle, 25 cm | 2418854 |
| Nozzle extension, with holder, without nozzle, 50 cm | 2418855 |
| Nozzle extension, with holder, without nozzle, 75 cm | 2418856 |
| Nozzle extension, with holder, without nozzle, 90 cm | 2418862 |
| Nozzle extension, with holder, without nozzle, 180 cm | 2418863 |

Nozzle extension – for more comfortable working and a wider reach

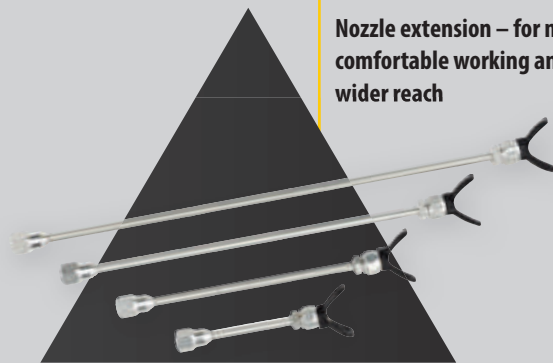

TipClean - easy cleaning and storage of your airless tips

**CLEANING AND STORAGE****Art. No.**

| | |
|---|---------|
| TipClean, container incl. special cleaner, 200 ml | 2400214 |
| EasyClean Cleaning and corrosion protection 1 l | 2412656 |
| EasyGlide, special oil, 118 ml | 508619 |

GUN FILTER**Art. No.**

| | |
|---|-------|
| Gun filter, red, extra fine, 180 MA, 0.084 mm MW | 34383 |
| Gun filter, red, extra fine, 180 MA, 0.084 mm MW, 10 pcs. | 97022 |
| Gun filter, yellow, fine, 100 MA, 0.14 mm MW | 43235 |
| Gun filter, yellow, fine, 100 MA, 0.14 mm MW, 10 pcs. | 97023 |
| Gun filter, white, medium, 50 MA, 0.31 mm MW | 34377 |
| Gun filter, white, medium, 50 MA, 0.31 mm MW, 10 pcs. | 97024 |
| Gun filter, green, coarse, 30 MA, 0.56 mm MW | 89323 |
| Gun filter, green, coarse, 30 MA, 0.56 mm MW, 10 pcs. | 97025 |

Gun filter – avoid nozzle blockages



ACCESSORIES – AIRCOAT

for wood and metal craft

Brilliant surfaces with AirCoat: The soft atomization guarantees brilliant surfaces and thus ensures perfect painting results.



AIRCOAT NOZZLES ACF 3000

The dome-shaped geometry and high-tech honing methods during manufacture ensure extremely fine atomisation with low energy consumption (material pressure). For a long service life and low wear and tear, the nozzle is made from resistant hard metal. The WAGNER AirCoat nozzle ensures brilliant surface finishes: An even spray pattern and extremely gentle graduated borders are guaranteed. This applies to both small and large quantities of atomised air.

Art. No.
379xxx

Orifice size (inch)

| Jet width (mm)* | Orifice size (inch) | | | | | | | | | | Spray angle in ° |
|-----------------|---------------------|-------|------------|-------|--------|-------|--------------|-------|-------|--|------------------|
| | 0.007 | 0.009 | 0.011 | 0.013 | 0.015 | 0.017 | 0.019 | 0.021 | 0.023 | | |
| 55 | 107 | | 111 | 113 | 115 | | | | | | 10 |
| 100 | 207 | 209 | 211 | 213 | 215 | 217 | 219 | 221 | | | 20 |
| 145 | 407 | 309 | 311 | 313 | 315 | 317 | 319 | | | | 30 |
| 195 | | 409 | 411 | 413 | 415 | 417 | 419 | 421 | 423 | | 40 |
| 250 | | 509 | 511 | 513 | 515 | 517 | 519 | 521 | | | 50 |
| 300 | | 609 | 611 | 613 | 615 | 617 | 619 | 621 | 623 | | 60 |
| 400 | | | 811 | 813 | 815 | 817 | 819 | 821 | 823 | | 80 |
| Filter | red | | red/yellow | | yellow | | yellow/white | white | | | |



AIRCOAT PRE-ATOMISATION NOZZLES ACF 3000 PLUS

AirCoat pre-atomisation nozzles provide extra fine atomisation even with low inlet air pressure. This is especially important for processing water- or solvent-based paints. Using a pre-atomisation nozzle allows you to work with less material and air quantity. There is significantly less overspray and material consumption decreases. Compared to the standard AirCoat nozzle the material is pre-atomised directly at the outer edge of the nozzle. The result: an especially even and soft spray pattern.

Art. No.
321xxx

Orifice size (inch)

| Jet width (mm)* | Orifice size (inch) | | | | | | | | Spray angle in ° | |
|-----------------|---------------------|-------|------------|-------|--------|--------------|-------|-------|------------------|----|
| | 0.008 | 0.010 | 0.012 | 0.014 | 0.016 | 0.018 | 0.020 | 0.022 | | |
| 100 | 208 | 210 | 212 | 214 | 216 | 218 | | | | 20 |
| 145 | 308 | 310 | 312 | 314 | 316 | 318 | 320 | | | 30 |
| 195 | 408 | 410 | 412 | 414 | 416 | 418 | 420 | 422 | | 40 |
| 250 | 508 | 510 | 512 | 514 | 516 | 518 | | | | 50 |
| 300 | | 610 | 612 | 614 | 616 | 618 | 620 | 622 | | 60 |
| Filter | red | | red/yellow | | yellow | yellow/white | white | | | |

* Spray width (mm) at approx. 30 cm distance from the object and 10 MPa (100 bar) pressure, with synthetic resin paint, 20 DIN seconds

** Measured with water at 12 MPa (120 bar) pressure

AIRCOAT MATERIALS

Only for AirCoat nozzles,
ACF 3000 & ACF 3000 Plus

 Water and solvent-based lacquers, lacquer paints, oils, separating agents

 Synthetic resin lacquers, PVC lacquers, 2K lacquers

 Primers, fillers

 Fillers, rust protection paints

 Fire protection, rust protection paints

 Corrosion protection

AIRCOAT GUN AC 4500

Art. No.

AirCoat gun AC 4500, incl. blue air cap and holder 2368269

AirCoat gun AC 4500, incl. green air cap and holder 2368270

AirCoat gun AC 4500, incl. red air cap and holder 2368271

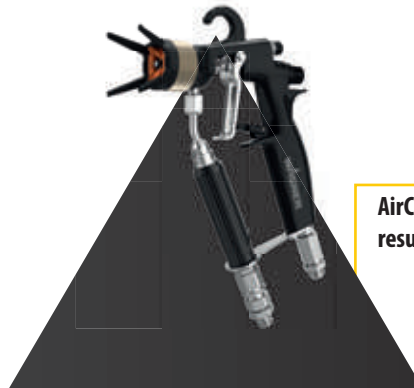

AirCoat AC 4500 for perfect surface results

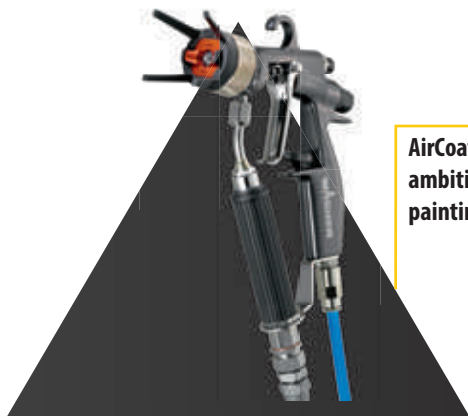

AirCoat AC 4600 for ambitious, comfortable painting work

AIRCOAT PISTOLE AC 4600

Art. No.

AC 4600 Professional, incl. blue air cap and holder 394156

AC 4600 Professional, incl. green air cap and holder 394158

AC 4600 Professional, incl. red air cap and holder 394157

AIRCOAT GUN ACCESSORIES

Art. No.

Air cap blue, for water-based materials (01) 394911

Air cap red, for solvent-based materials (02) 394910

Air cap green, for water-based materials and solvent-based materials (03) 394912

Union nut, complete (04) 394921

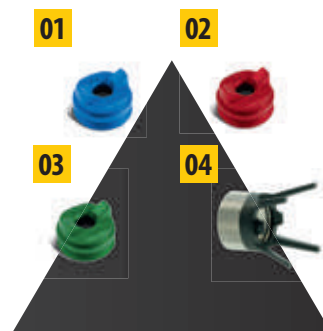

Various air caps for different applications

ACCESSORIES – PLASTCOAT

CONTINUOUS MIXER

Art. No.

| | |
|-------------------------------------|---------|
| PlastMix 15, with steel mixing tube | 2348669 |
| PlastMix 15, with PUR mixing tube | 2359240 |



Continuous mixer for dry materials

PlastGuard longlasting - to protect the device and for optimum storage



ACCESSORIES FOR PLASTCOAT HP 30

Art. No.

| | |
|--|---------|
| PlastGuard longlasting pump protector, 5 l | 2399960 |
| PlastCoat HP 30 emulsion set | 2400684 |

Cleaning balls – for cleaning out hoses and avoiding nozzle blockages

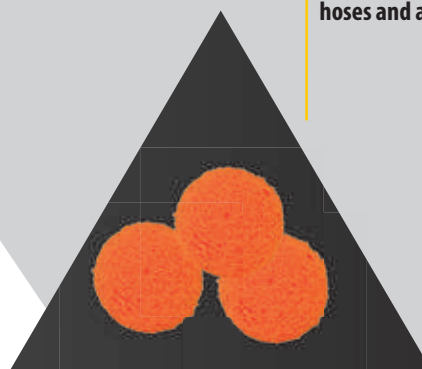

CLEANING AND STORAGE

Art. No.

| | |
|--|---------|
| Brush with handle and cap | 9100095 |
| Bottle brush for cleaning interior of outlet unit and spraying lance | 342329 |
| Cleaning adapter M27GK | 342241 |
| Cleaning brush, 280 to 420 mm long | 348959 |
| Cleaning ball DN16 | 2402355 |
| Cleaning ball DN19 | 342330 |

Bag processing table – for the convenient emptying of bagged goods

SUPPORT TABLE INCL. ROLLER PRESS

Art. No.

| | |
|-----------------------------|---------|
| Support table, for PC 830 | 2318389 |
| Support table, for PC HP 30 | 2389048 |

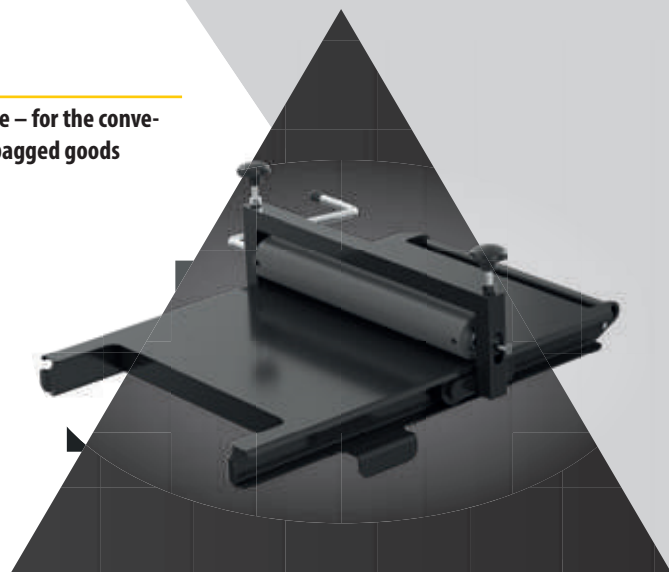

Current prices and further information about our products can be found here:
go.wagner-group.com/produkte



BE UNSTOPPABLE!

VISIT US AT

